

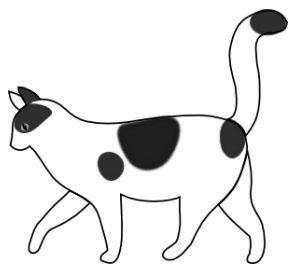

# 3 Letter Word Shapes



cat



Blank 3-letter word shape grid

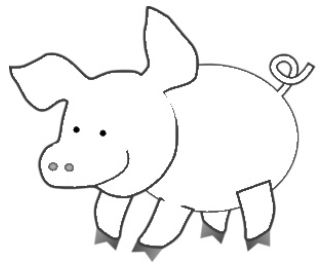

Blank 3-letter word shape grid



Blank 3-letter word shape grid



Blank 3-letter word shape grid



Blank 3-letter word shape grid



Blank 3-letter word shape grid

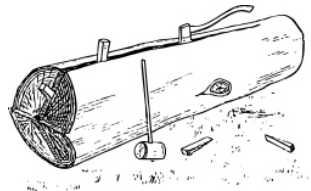

Blank 3-letter word shape grid

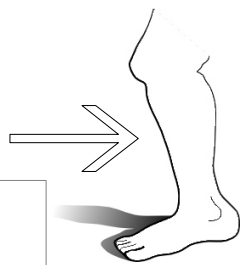

Blank 3-letter word shape grid

# 3 Letter Word Shapes

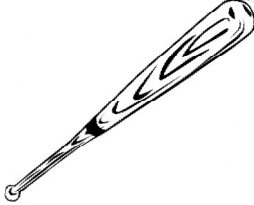

A line drawing of a baseball bat, angled diagonally from the bottom-left to the top-right.

|  |  |  |
|--|--|--|
|  |  |  |
|--|--|--|

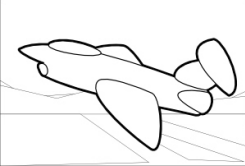

A line drawing of a jet airplane in flight, angled upwards.

|  |  |  |
|--|--|--|
|  |  |  |
|--|--|--|



A line drawing of a hen standing on a small patch of grass.

|  |  |  |
|--|--|--|
|  |  |  |
|--|--|--|



A line drawing of a baseball cap with a brim.

|  |  |  |
|--|--|--|
|  |  |  |
|--|--|--|

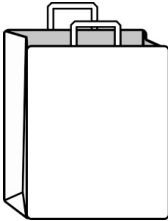

A line drawing of a shopping bag with a handle.

|  |  |  |
|--|--|--|
|  |  |  |
|--|--|--|



A line drawing of a school bus with the words "SCHOOL BUS" written on its side.

|  |  |  |
|--|--|--|
|  |  |  |
|--|--|--|



A line drawing of a mug with steam rising from it, indicating a hot beverage.

|  |  |  |
|--|--|--|
|  |  |  |
|--|--|--|

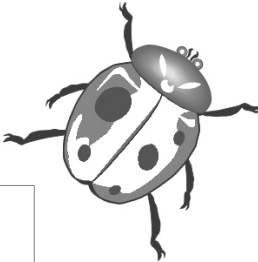

A line drawing of a ladybug with spots on its back.

|  |  |  |
|--|--|--|
|  |  |  |
|--|--|--|

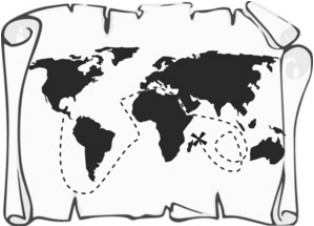

A line drawing of a world map on a scroll, showing continents and a dashed line representing a path.

|  |  |  |
|--|--|--|
|  |  |  |
|--|--|--|

# 3 Letter Word Shapes



Blank word shape boxes: a vertical rectangle on the left, and two smaller vertical rectangles side-by-side on the right.



Blank word shape boxes: three vertical rectangles side-by-side.

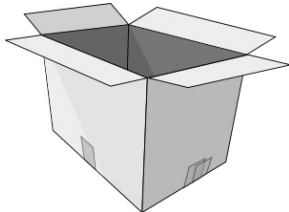

Blank word shape boxes: a vertical rectangle on the left, and two smaller vertical rectangles side-by-side on the right.



Blank word shape boxes: three vertical rectangles side-by-side.



Blank word shape boxes: two tall vertical rectangles on the left and right, and a shorter vertical rectangle in the middle.



Blank word shape boxes: two vertical rectangles side-by-side on the left, and a taller vertical rectangle on the right.



Blank word shape boxes: a vertical rectangle on the left, and two smaller vertical rectangles side-by-side on the right.



Blank word shape boxes: three vertical rectangles side-by-side.

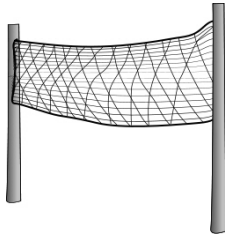

Blank word shape boxes: two vertical rectangles side-by-side on the left, and a taller vertical rectangle on the right.

# 3 Letter Word Shapes

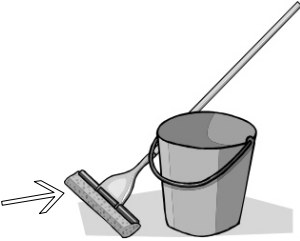

A bucket of paint and a brush with an arrow pointing to the brush head.

|  |  |  |
|--|--|--|
|  |  |  |
|--|--|--|

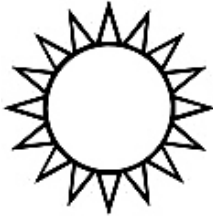

A simple line drawing of a sun with rays.

|  |  |  |
|--|--|--|
|  |  |  |
|--|--|--|



A silhouette of a bat with wings spread.

|  |  |  |
|--|--|--|
|  |  |  |
|--|--|--|



A drawing of a pen with an arrow pointing to the tip.

|  |  |  |
|--|--|--|
|  |  |  |
|--|--|--|

10

|  |  |  |
|--|--|--|
|  |  |  |
|--|--|--|

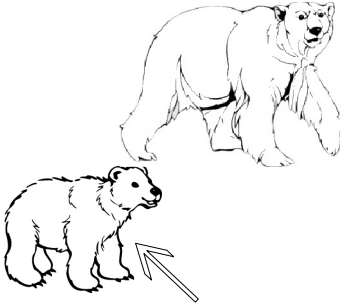

A large polar bear and a smaller cub with an arrow pointing to the cub.

|  |  |  |
|--|--|--|
|  |  |  |
|--|--|--|

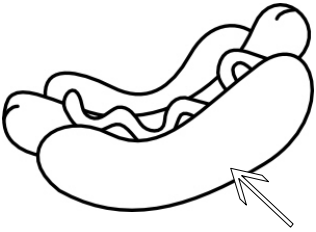

A hot dog in a bun with an arrow pointing to the bun.

|  |  |  |
|--|--|--|
|  |  |  |
|--|--|--|

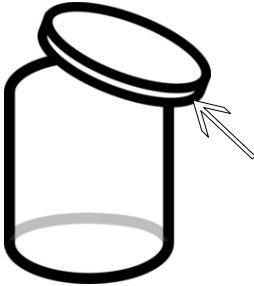

A jar with a lid and an arrow pointing to the lid.

|  |  |  |
|--|--|--|
|  |  |  |
|--|--|--|



A drawing of a paperclip.

|  |  |  |
|--|--|--|
|  |  |  |
|--|--|--|

Print word cards off on card stock. Go through the cards pointing out the tall letters, short letters, the letters that hang down. Sound the words out. Talk about the pictures. You're now ready to do wordshape puzzles.

## Word Cards

[school4free.blogspot.com](http://school4free.blogspot.com)

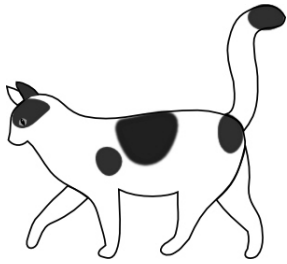

cat



bed

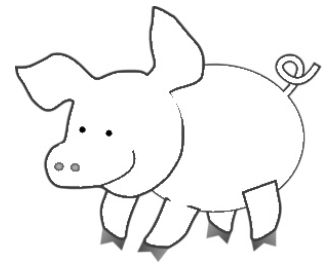

pig



dog



hat



pan



egg

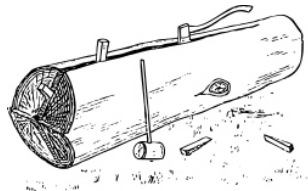

log

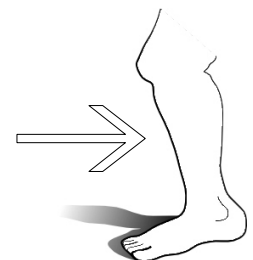

leg

# Word Cards

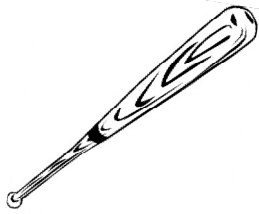

pen

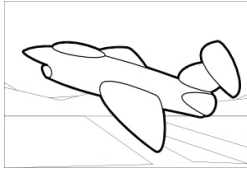

jet



hen



cap

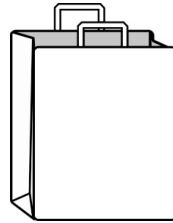

bag



bus



cup



bug

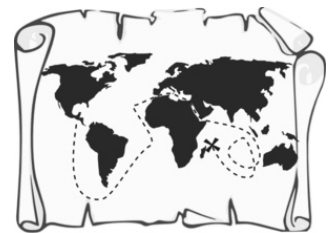

map

# Word Cards



fan



man

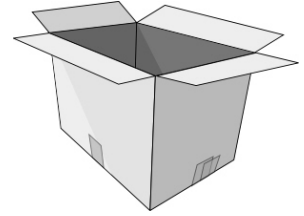

box



can



tub



rat



fox



van

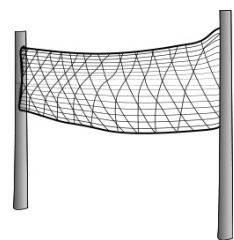

net

# Word Cards

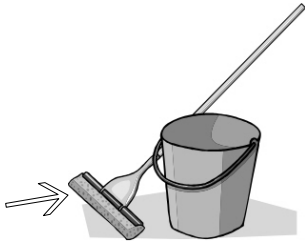

mop

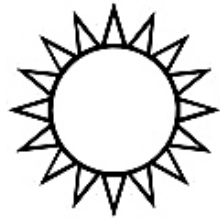

sun



bat



pen

10

ten

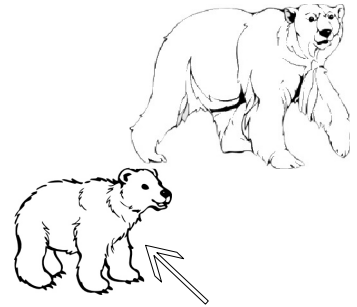

cub

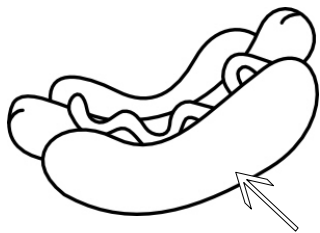

bun

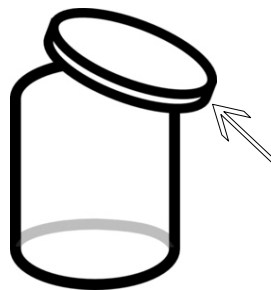

lid



pin