

My Letter

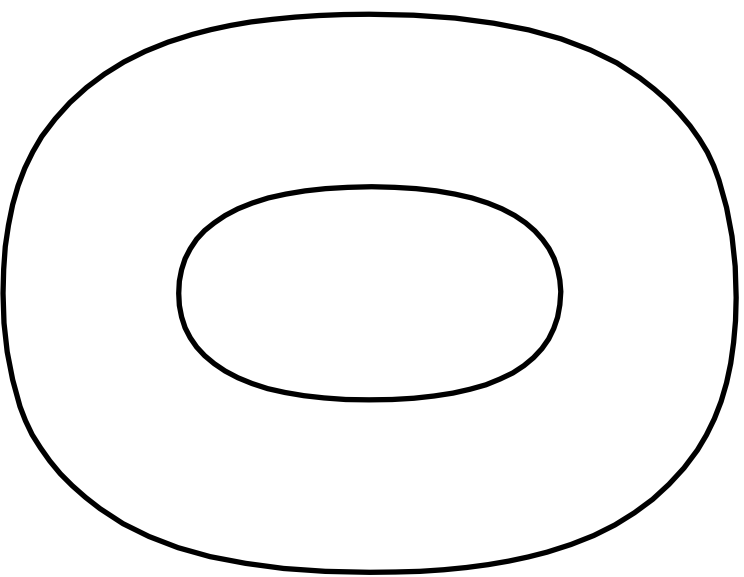

Book

Name

O o

is for

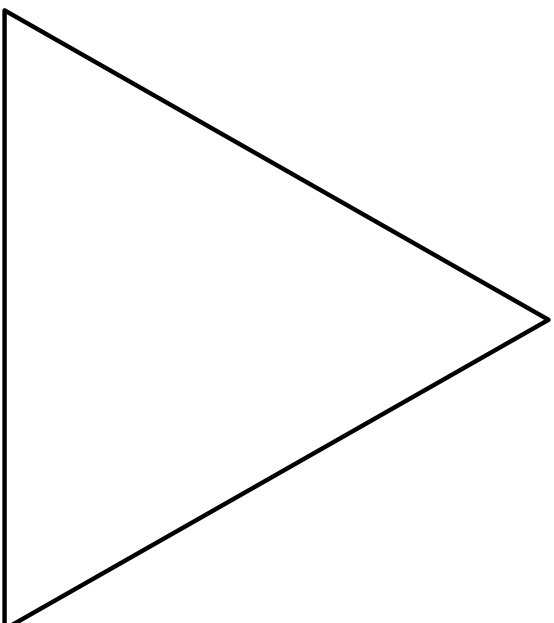

octopus

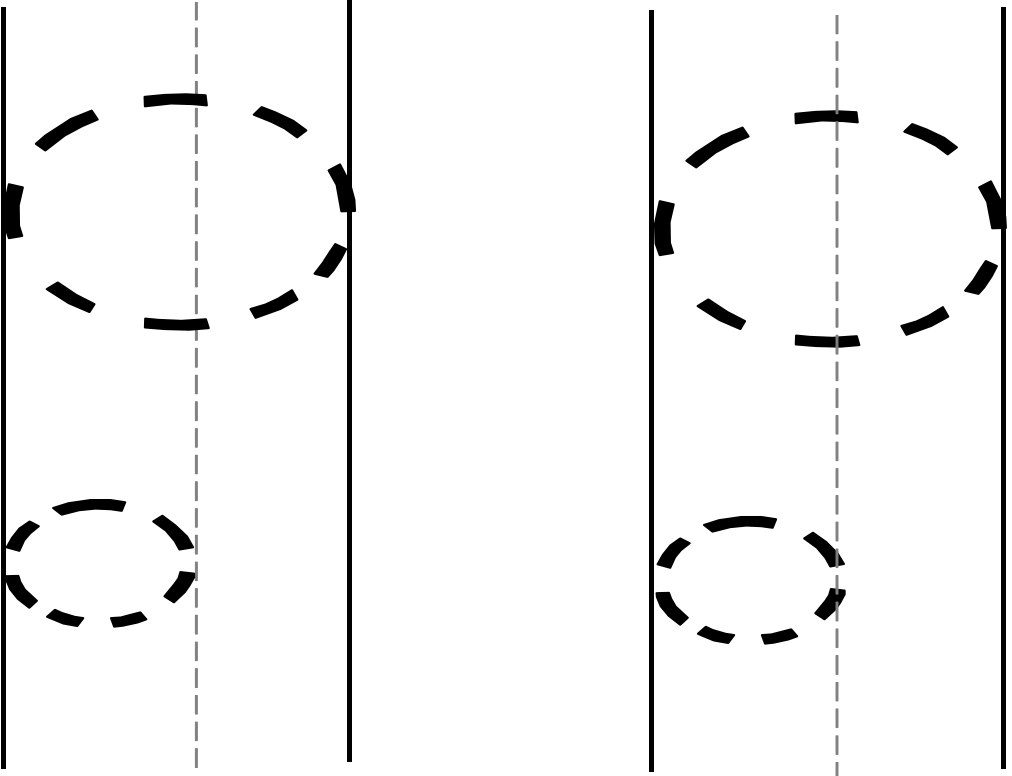

O o

is for

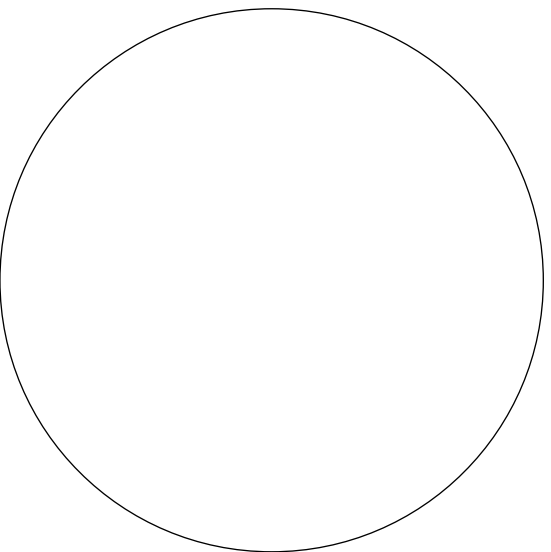

otter

O o

is for

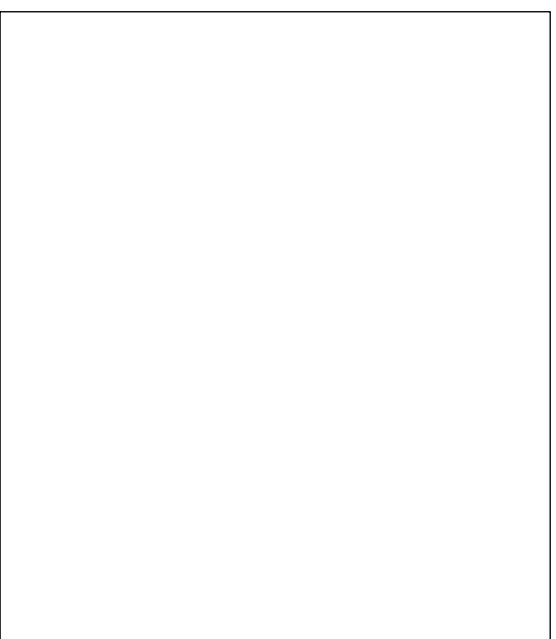

ostrich

O o

is for

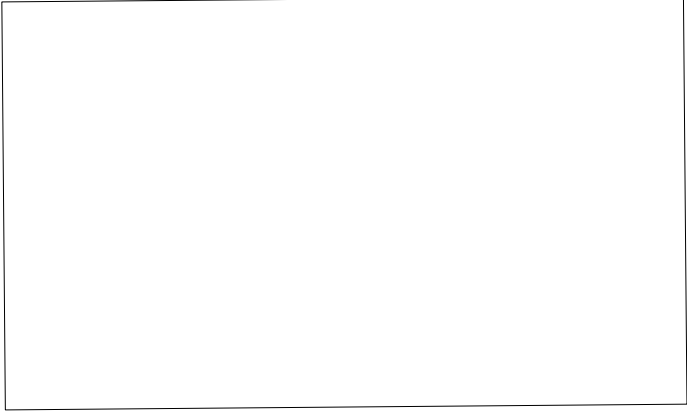

olive

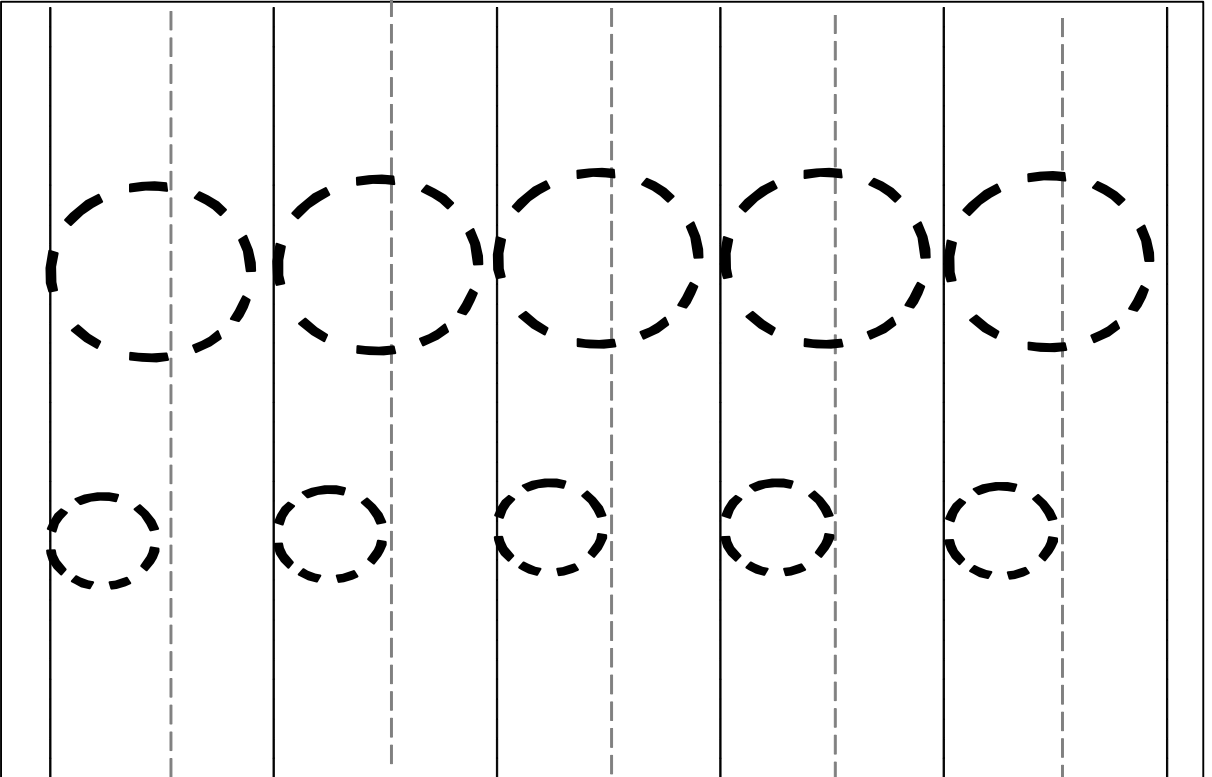

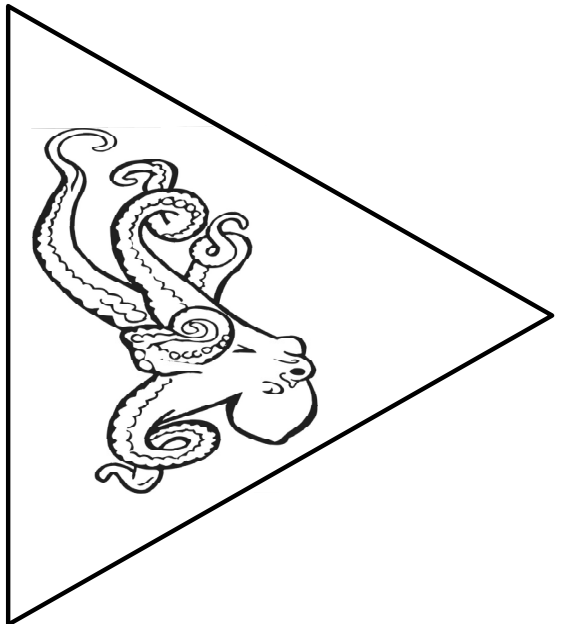
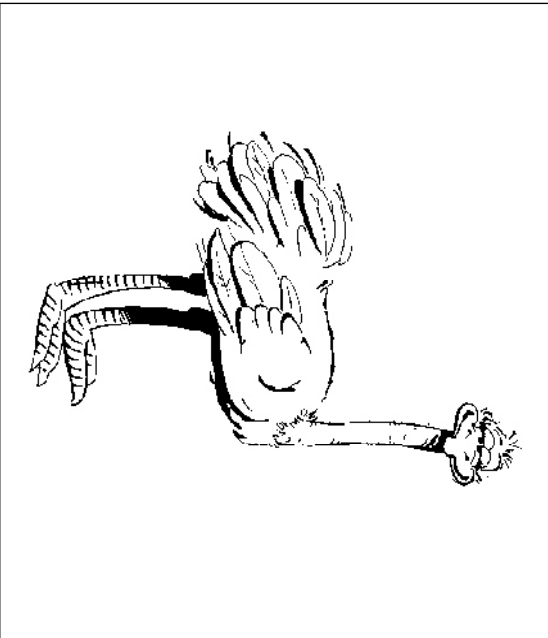
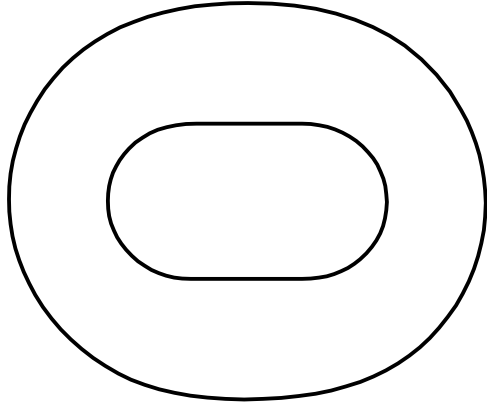
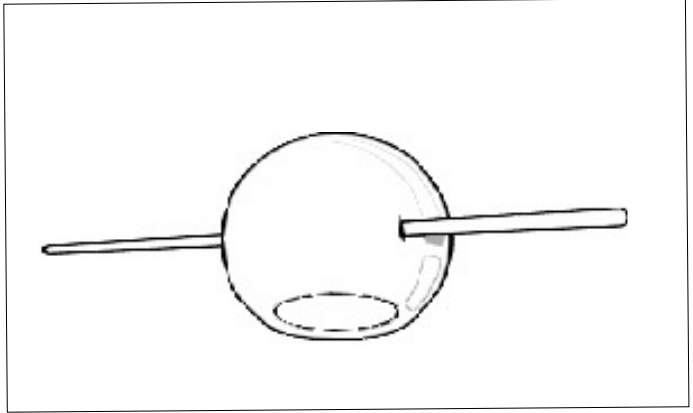

My Letter

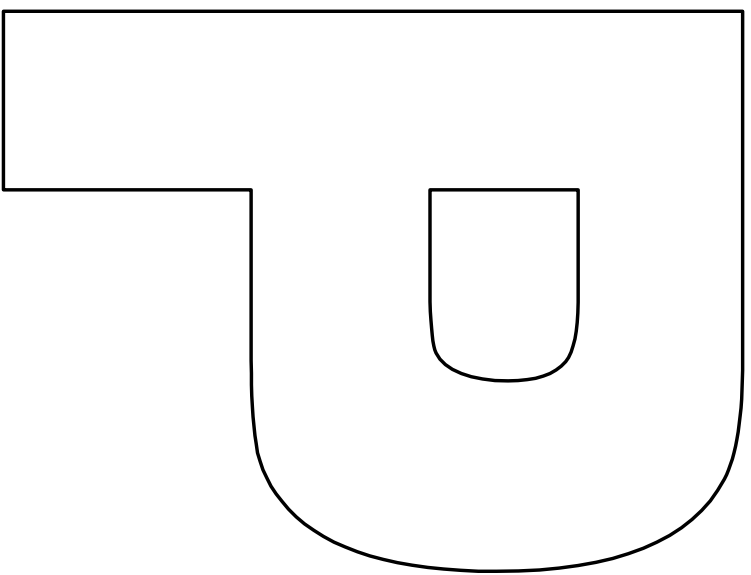

Book

Name

P p

is for

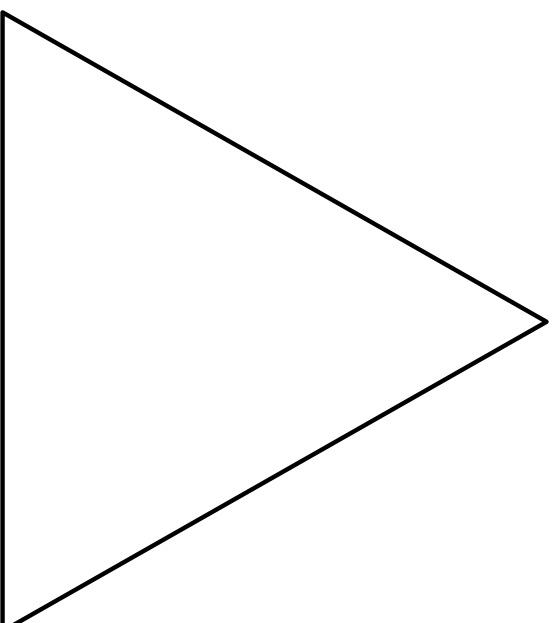

penguin

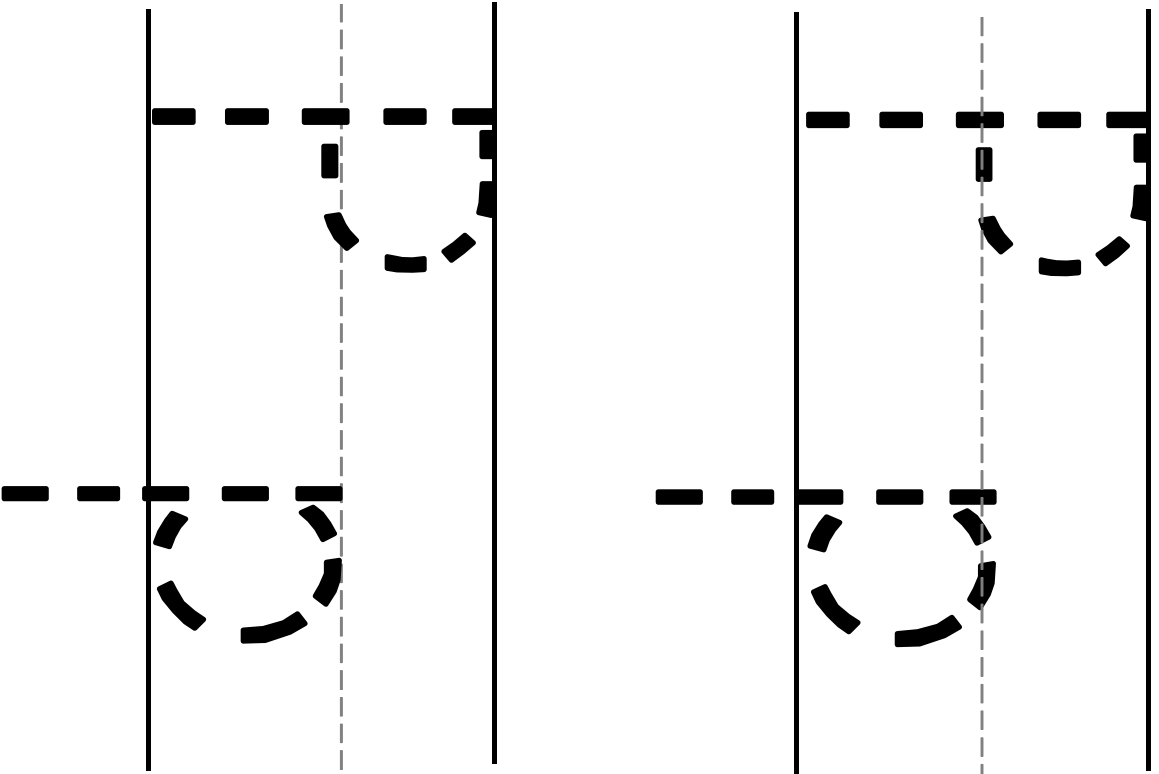

P p

is for

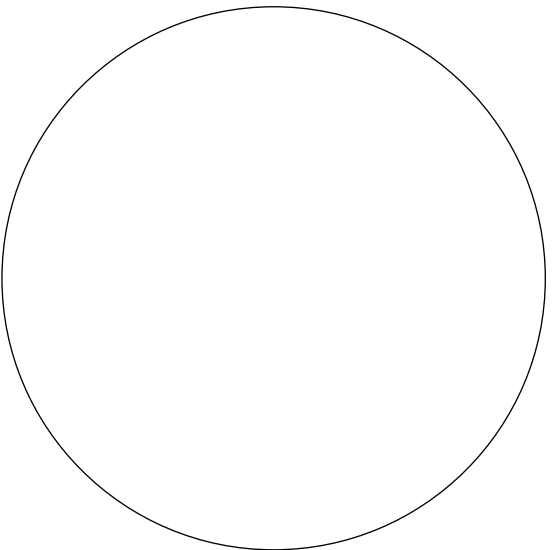

pear

P p

is for

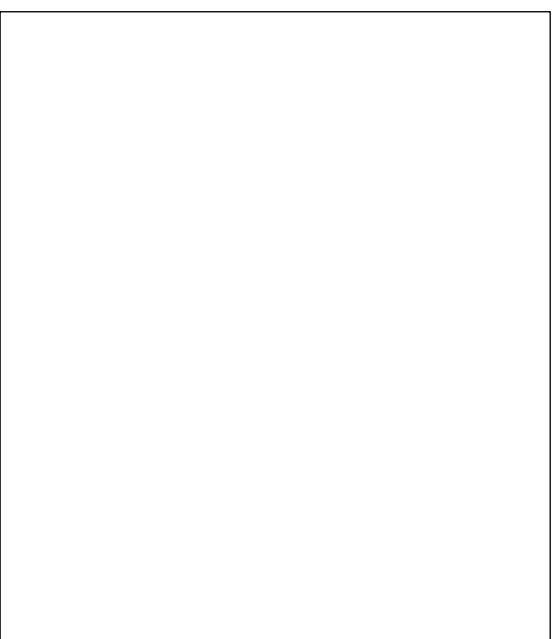

pan

P p

is for

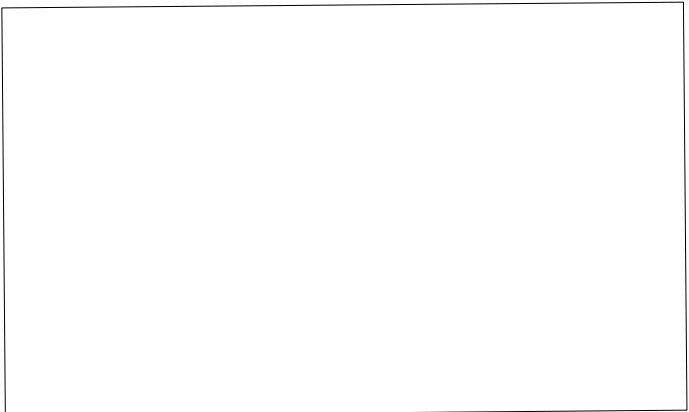

popcorn

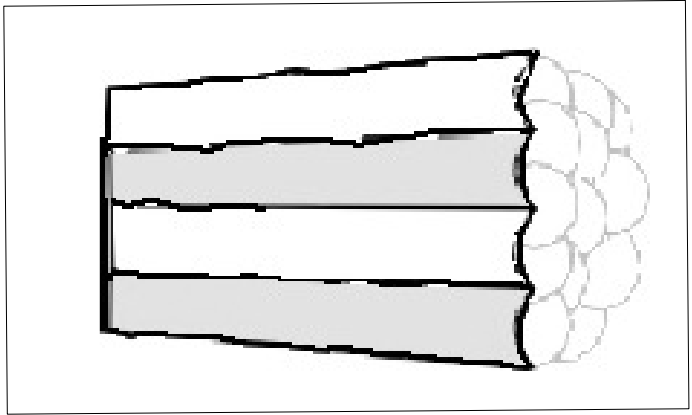
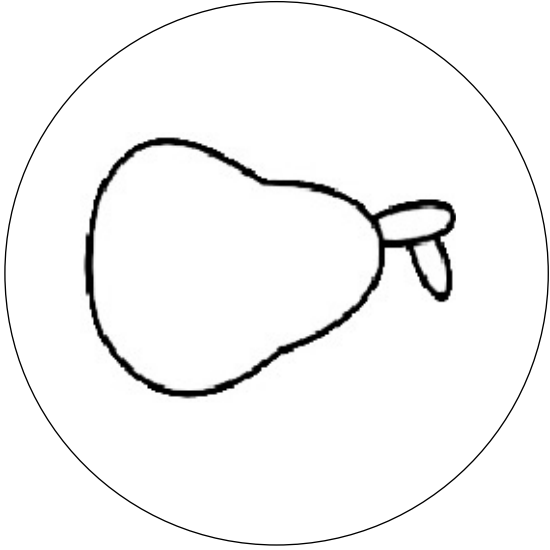

U

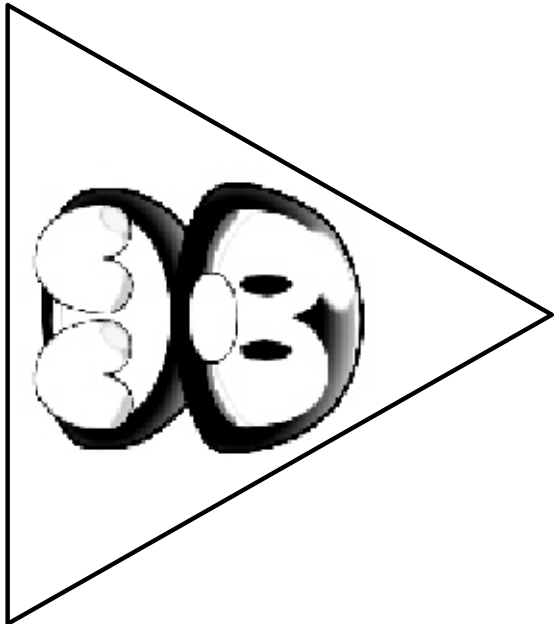

My Letter

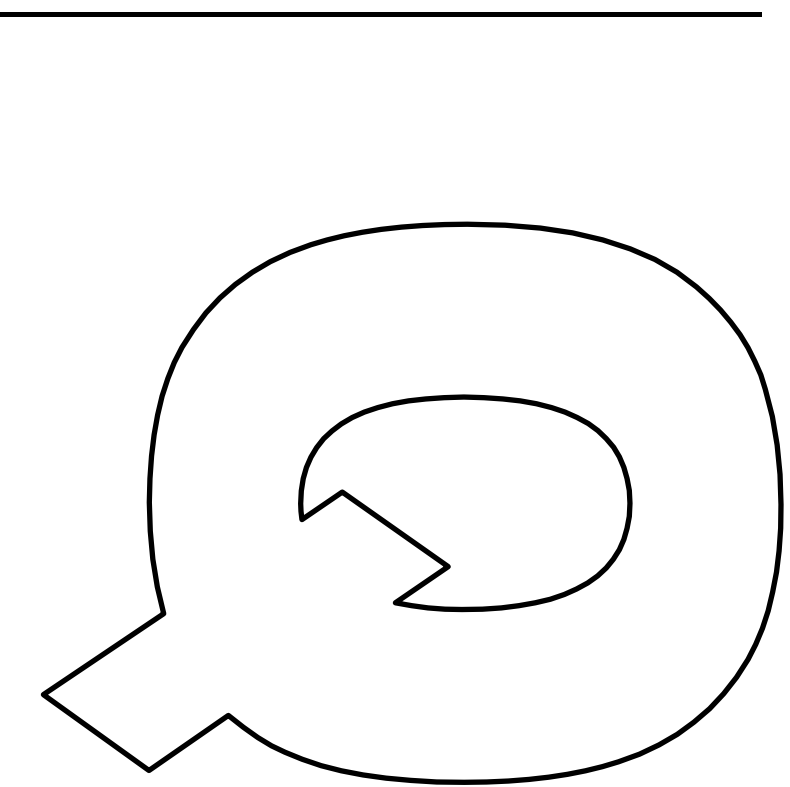

Book

Name

Q q

is for

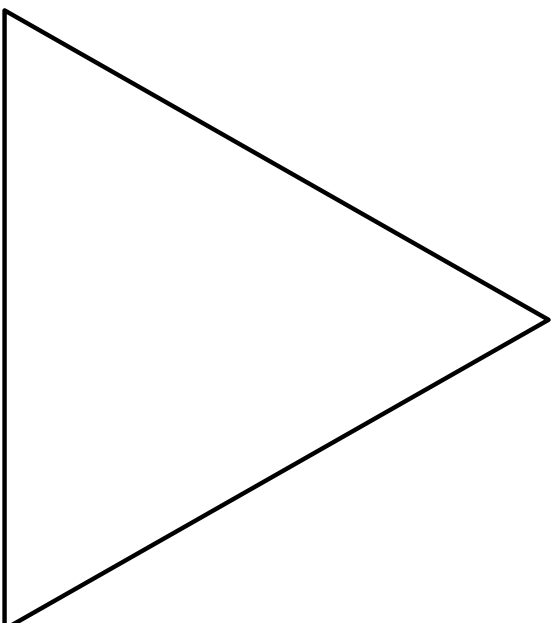

quiet

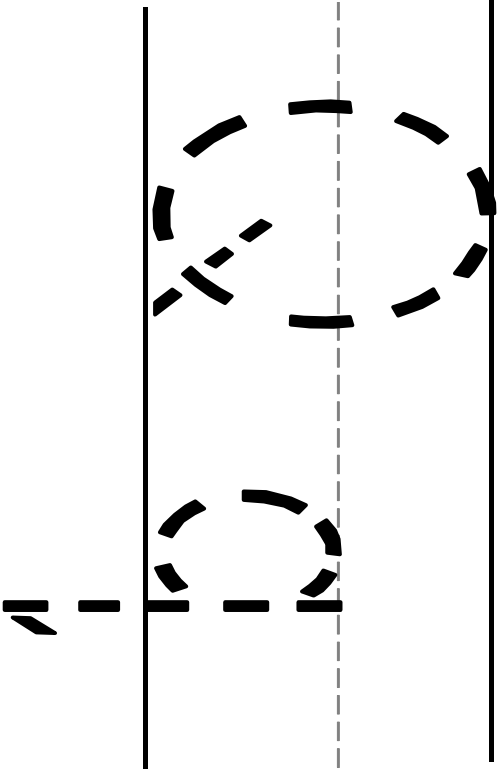
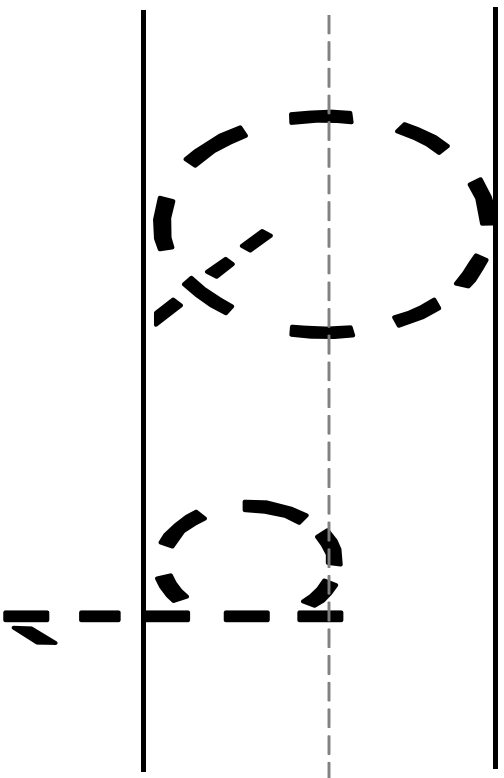

Q q

is for

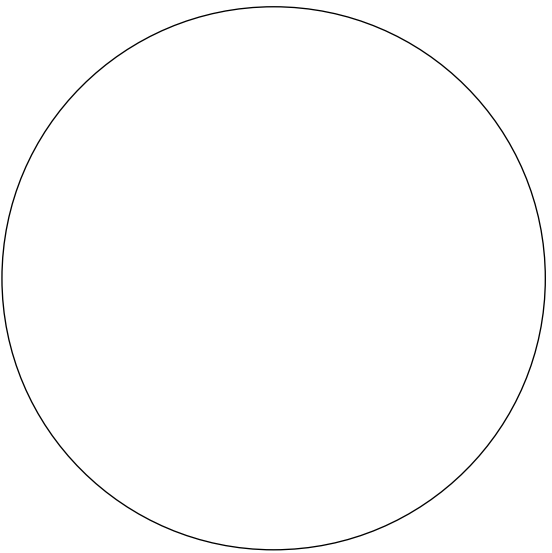

quarter

Q q

is for

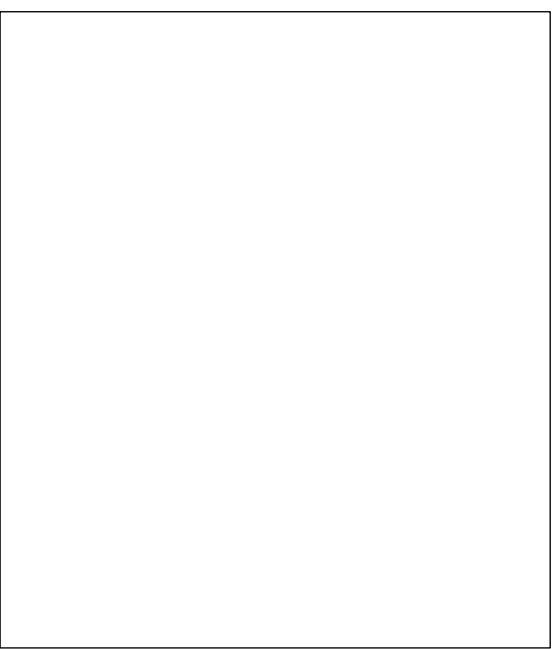

quilt

Q q

is for

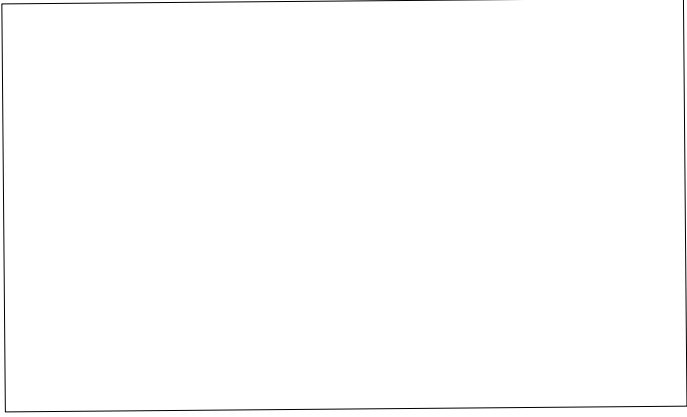

queen

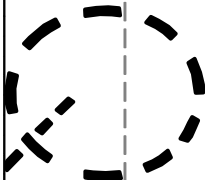
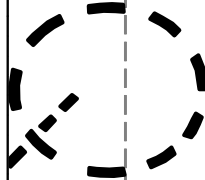
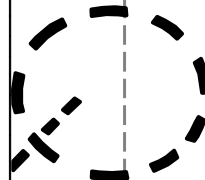
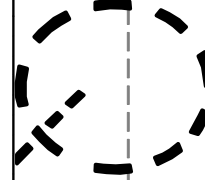
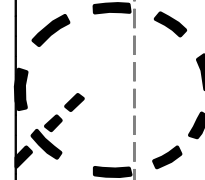
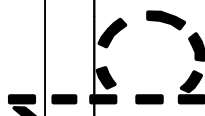
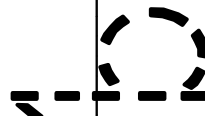
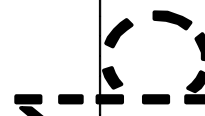
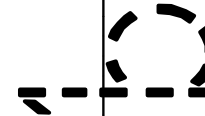
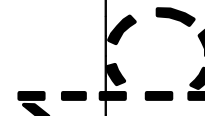

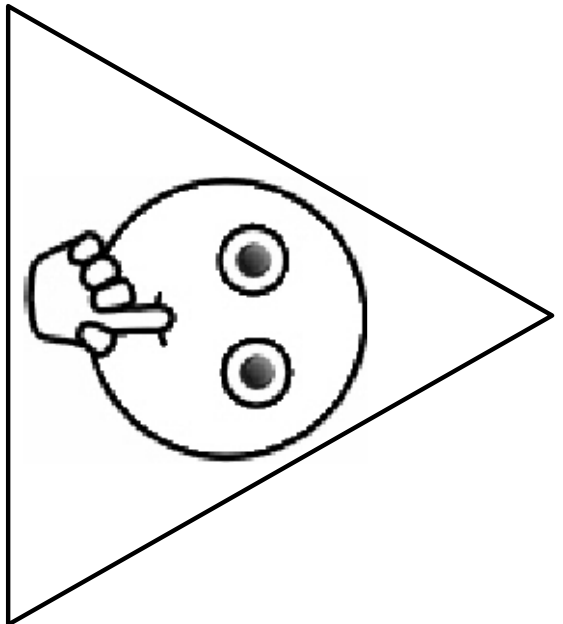
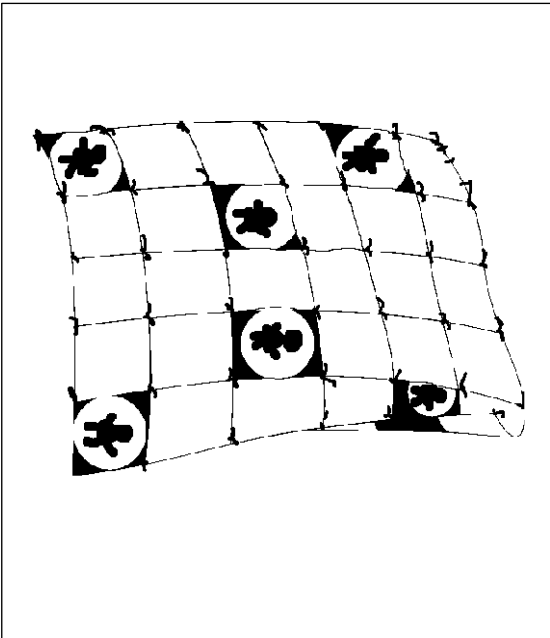
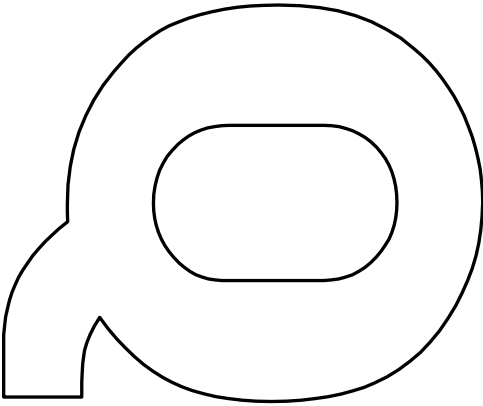
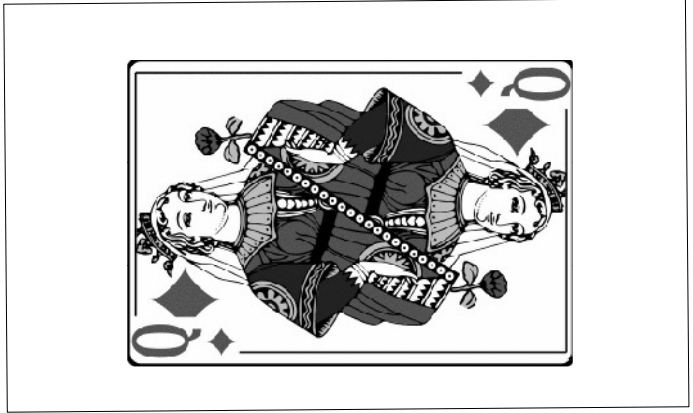
My Letter

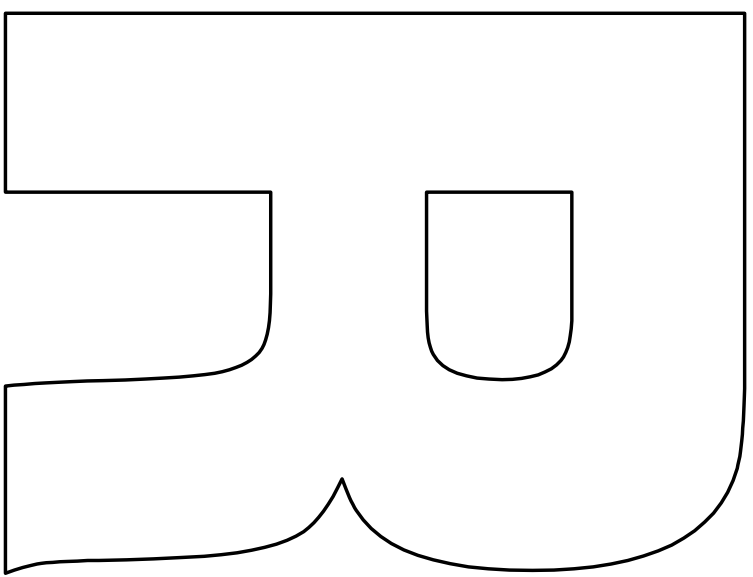

Book

Name

R r

is for

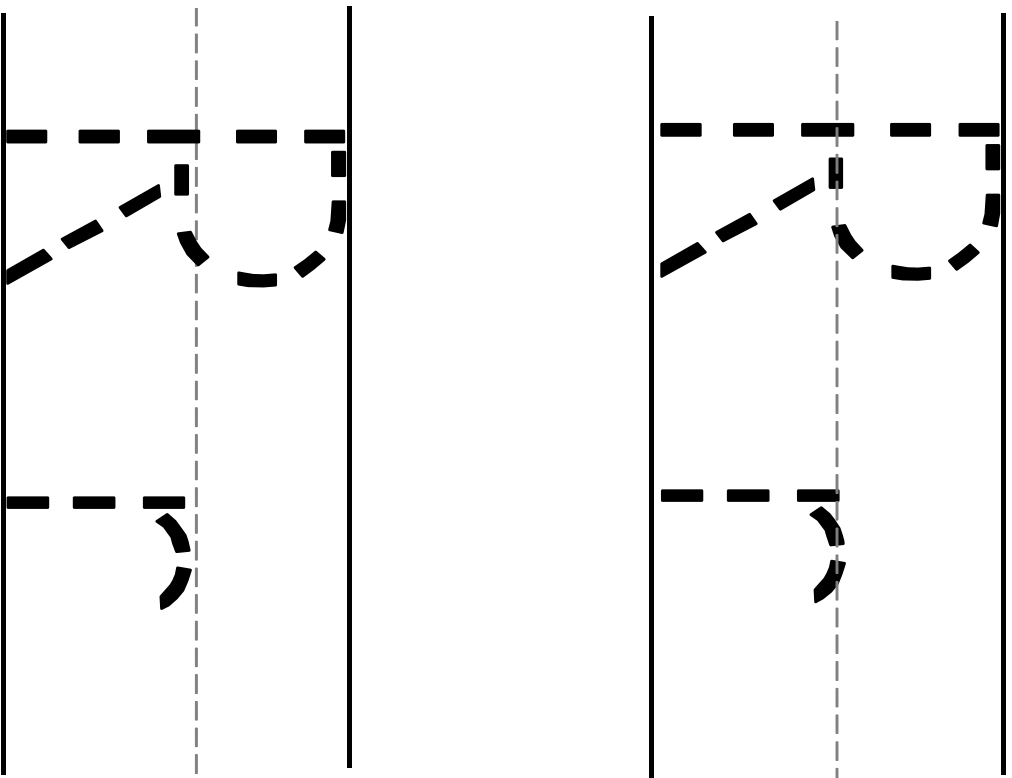
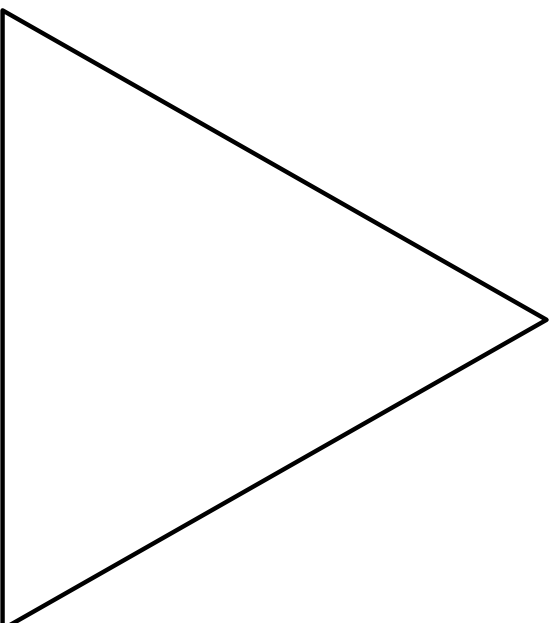

rain

R r

is for

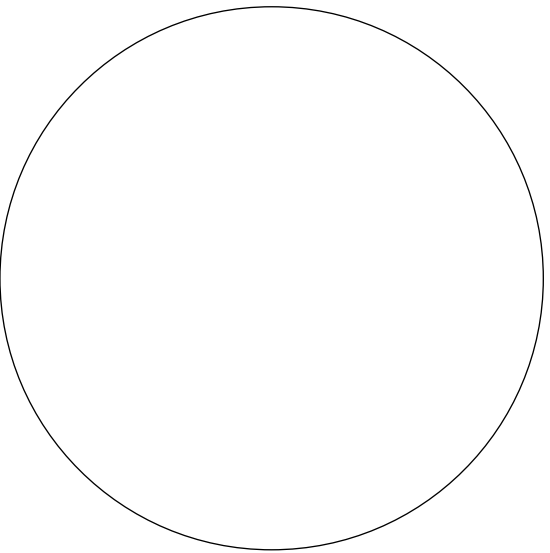

rooster

R r

is for

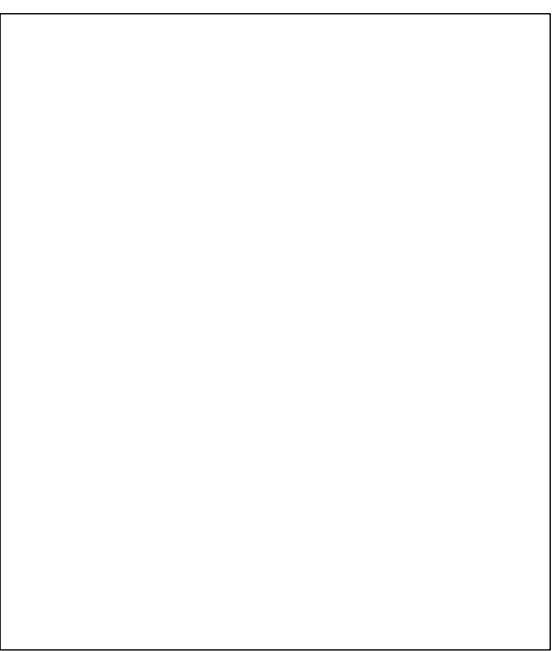

rabbit

R r

is for

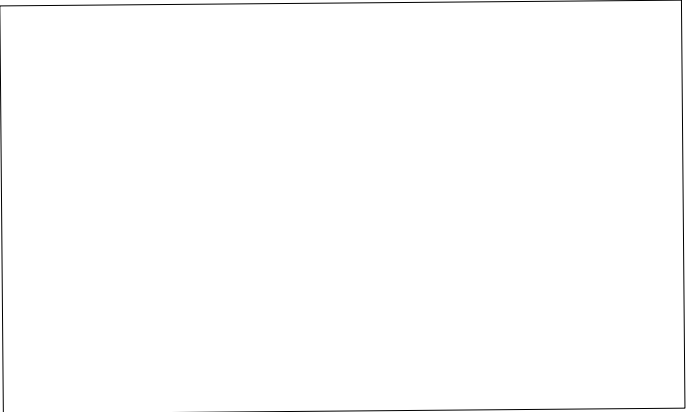

rocket

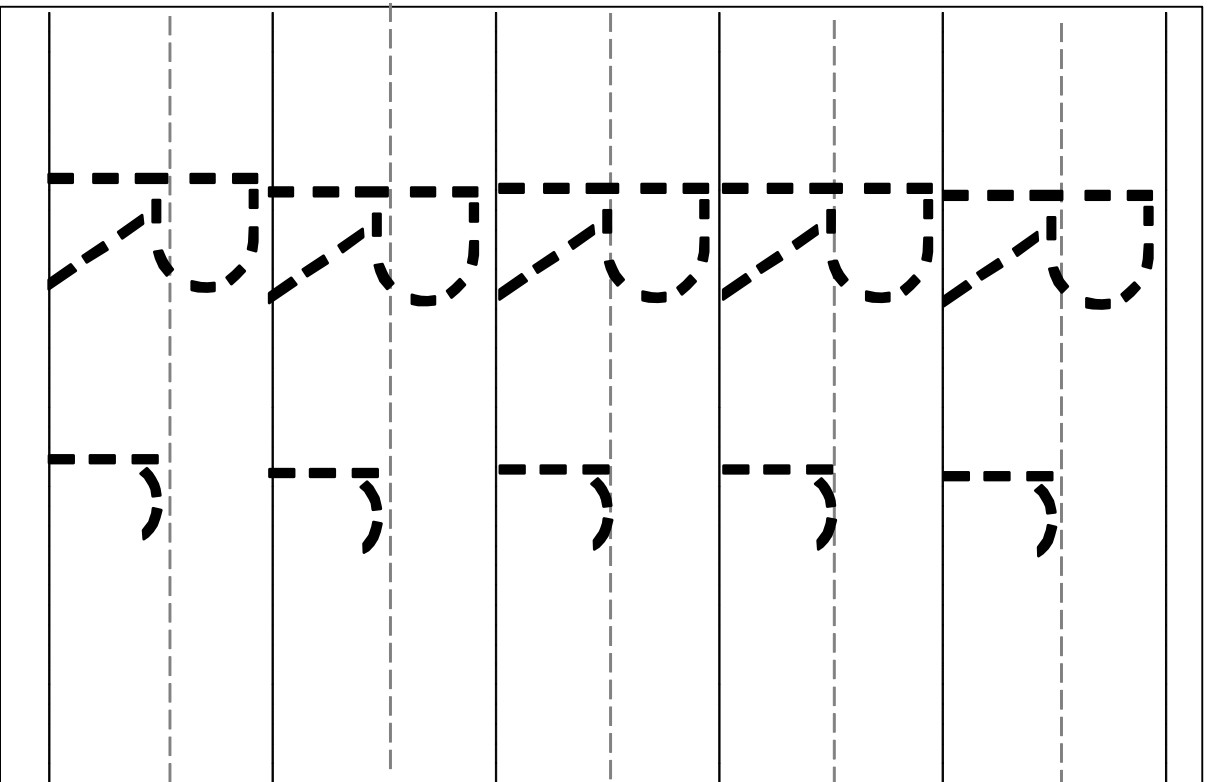

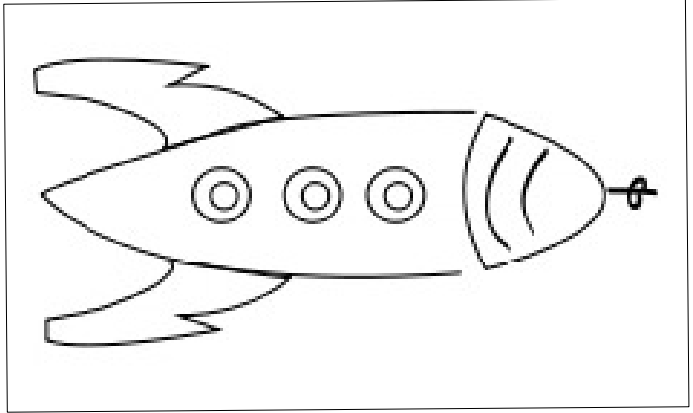

R

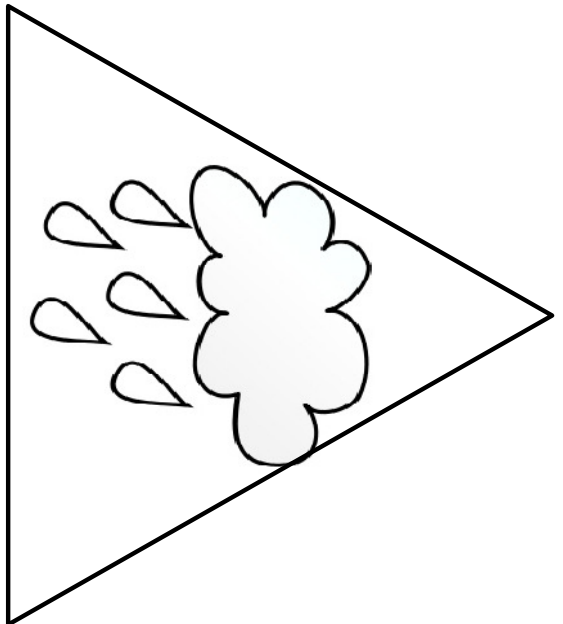
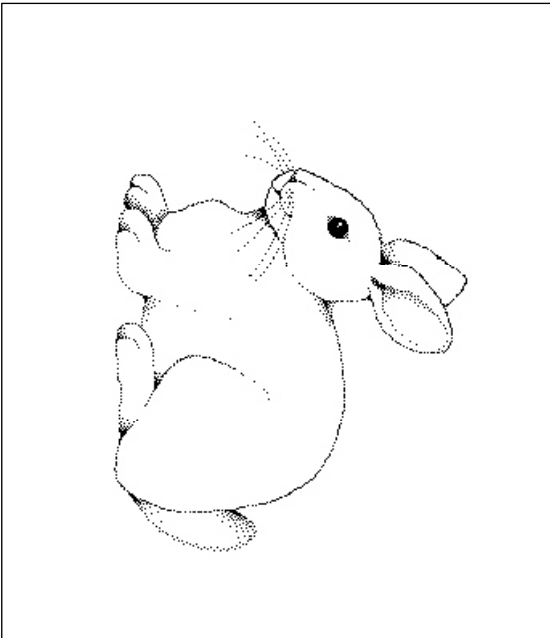

My Letter

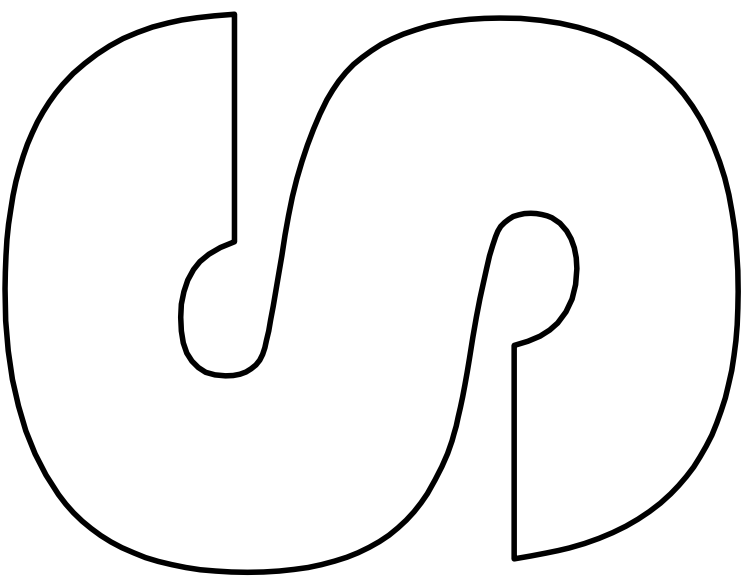

Book

Name

S s

is for

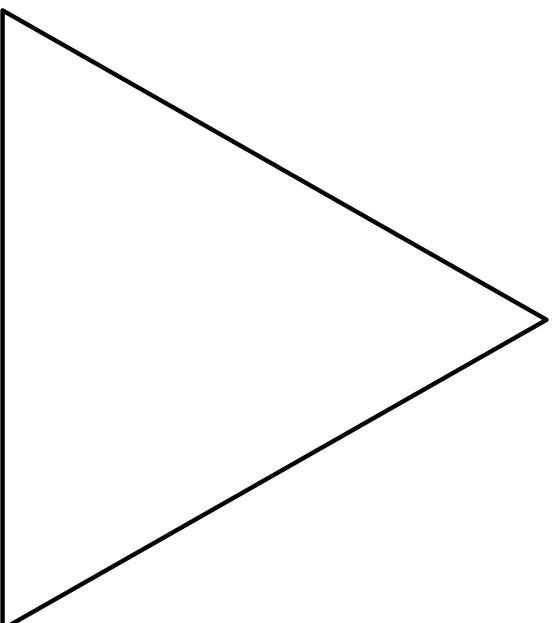

sandwich

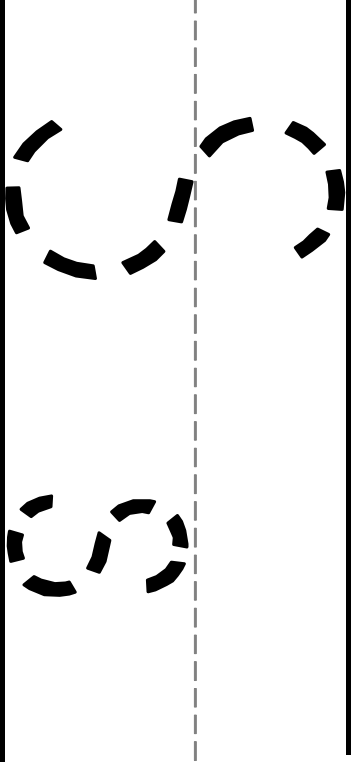
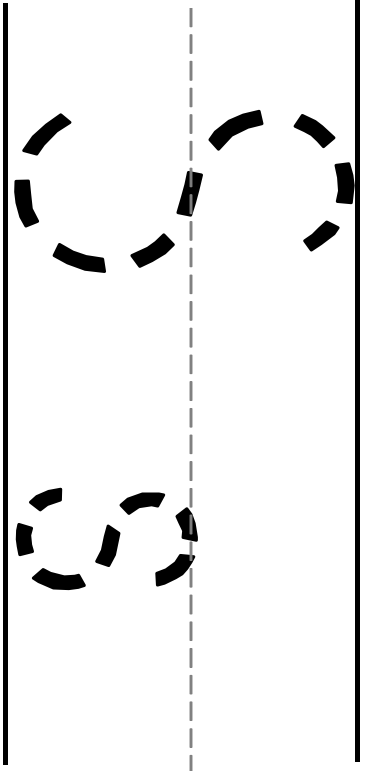

S s

is for

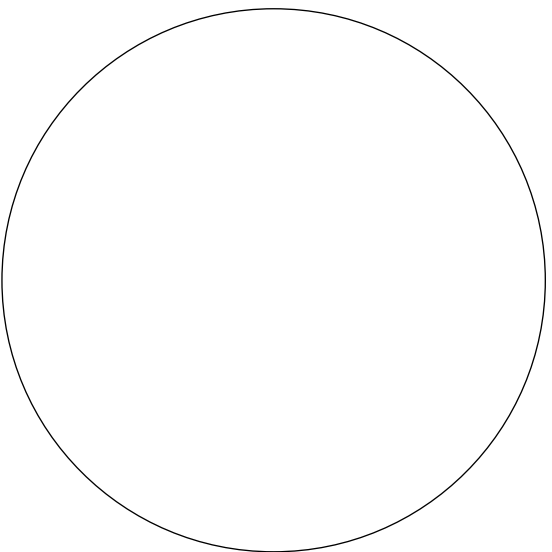

seal



S s

is for

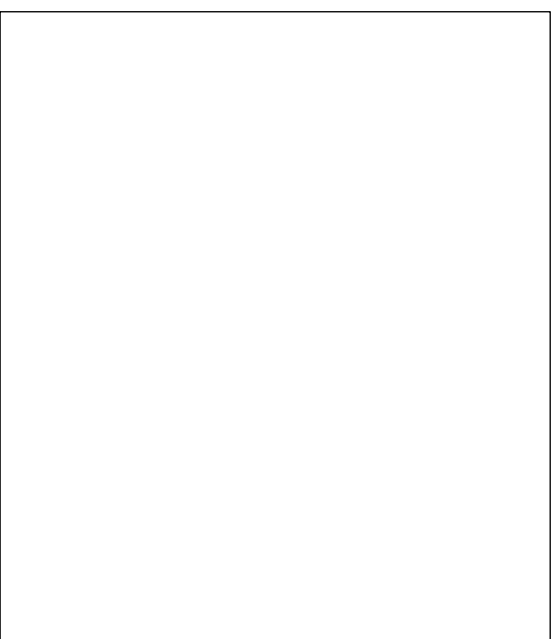

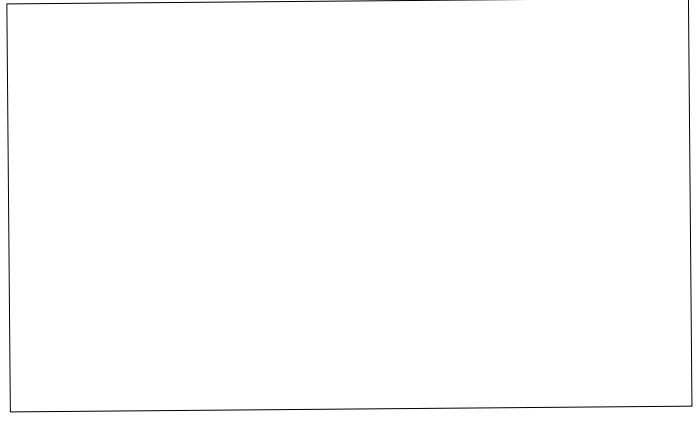

snake

sun

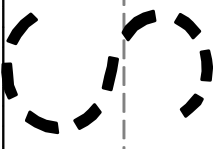

is for

S s

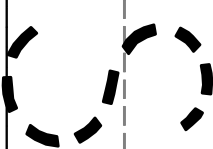
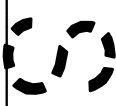
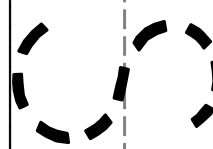
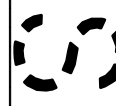
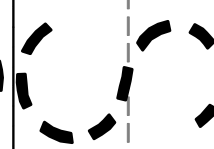
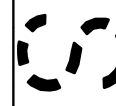
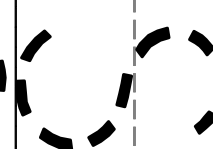
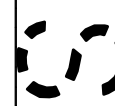

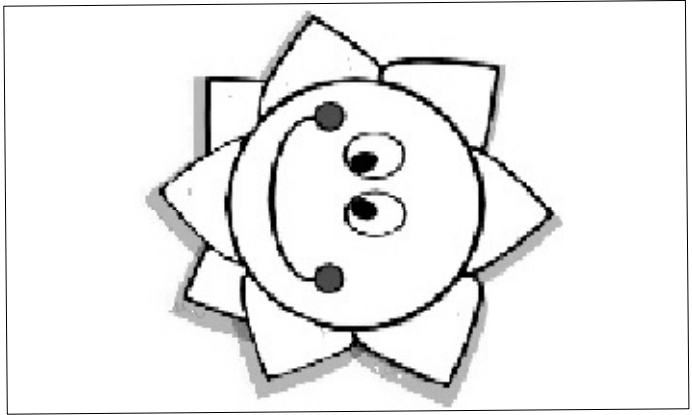
S

