

My Letter

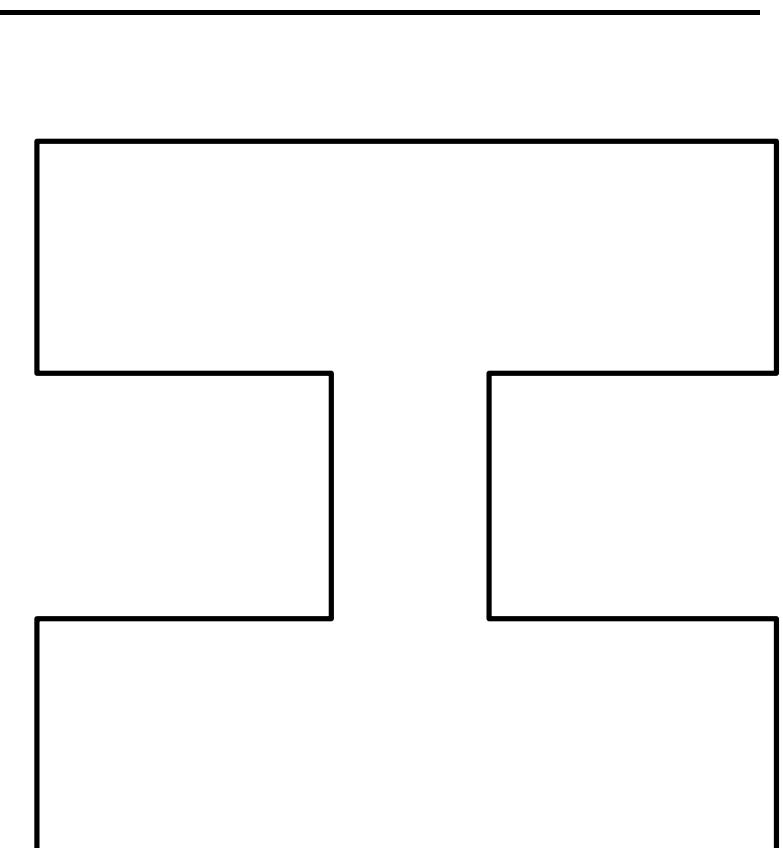

Book

Name

hot dog

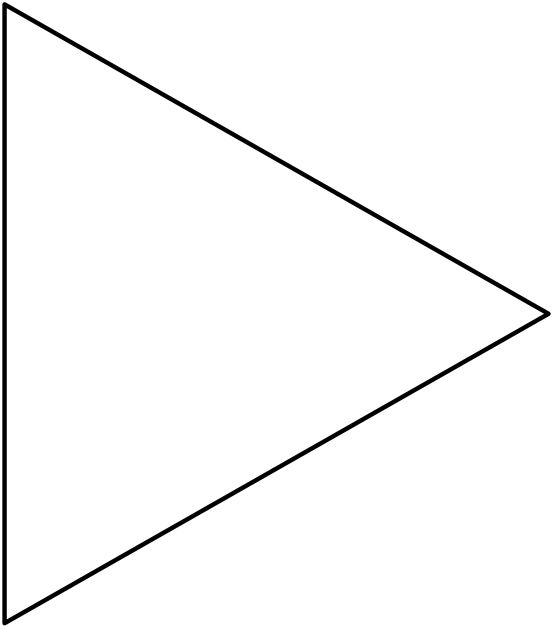

is for

H h

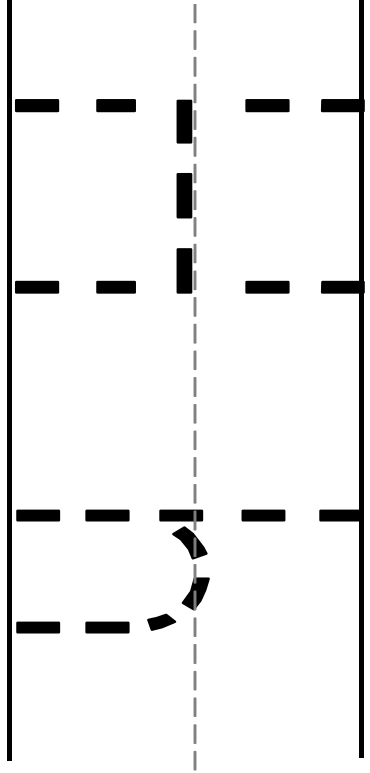
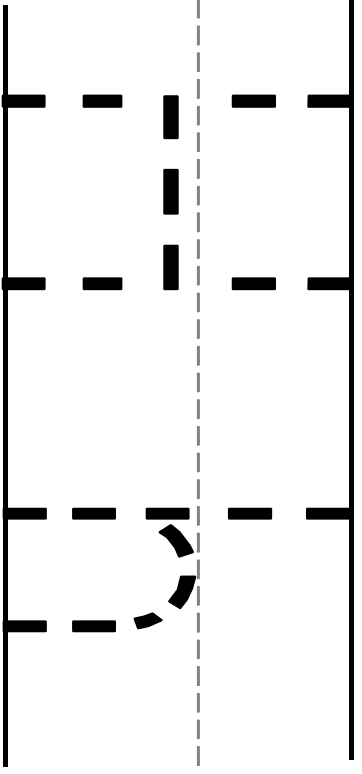

H h

is for

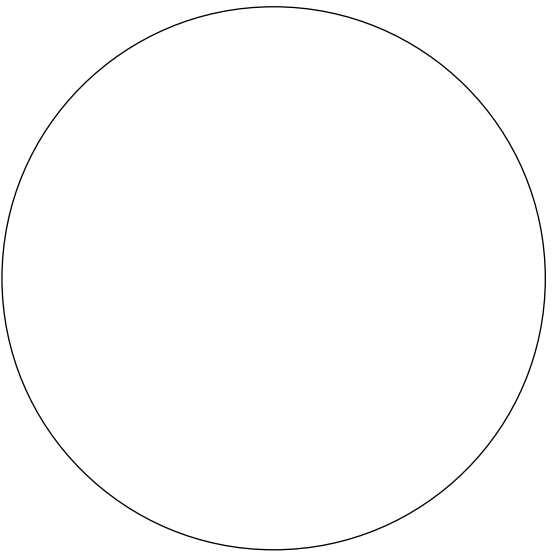

helicopter

H h

is for

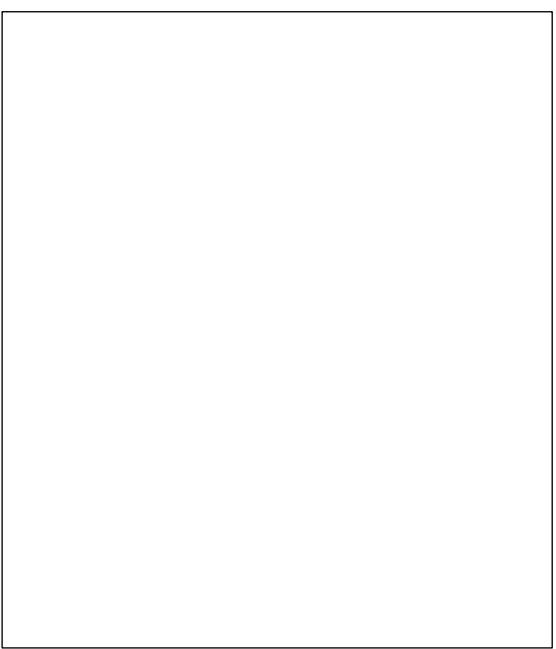

horse

H h

is for

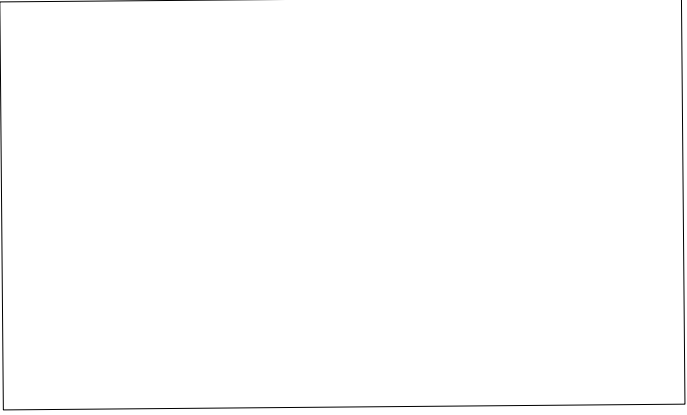

hat

A dashed uppercase letter 'H' positioned between the top and middle dashed lines of a set of handwriting lines.	A dashed lowercase letter 'h' positioned between the middle and bottom dashed lines of a set of handwriting lines.
A dashed uppercase letter 'H' positioned between the top and middle dashed lines of a set of handwriting lines.	A dashed lowercase letter 'h' positioned between the middle and bottom dashed lines of a set of handwriting lines.
A dashed uppercase letter 'H' positioned between the top and middle dashed lines of a set of handwriting lines.	A dashed lowercase letter 'h' positioned between the middle and bottom dashed lines of a set of handwriting lines.
A dashed uppercase letter 'H' positioned between the top and middle dashed lines of a set of handwriting lines.	A dashed lowercase letter 'h' positioned between the middle and bottom dashed lines of a set of handwriting lines.
A dashed uppercase letter 'H' positioned between the top and middle dashed lines of a set of handwriting lines.	A dashed lowercase letter 'h' positioned between the middle and bottom dashed lines of a set of handwriting lines.

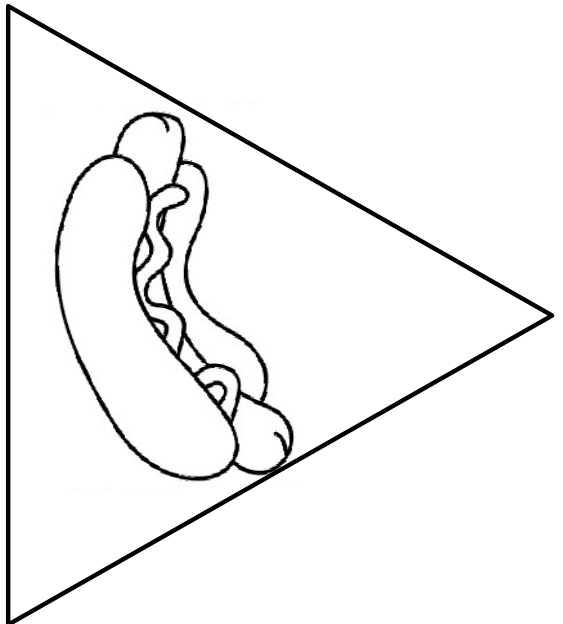
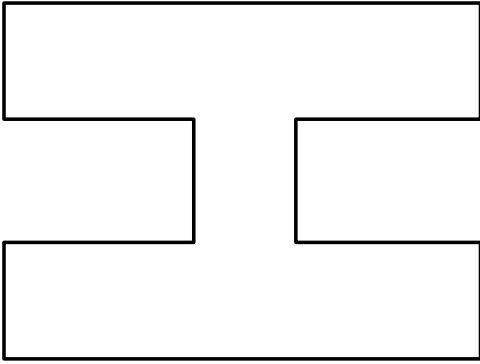
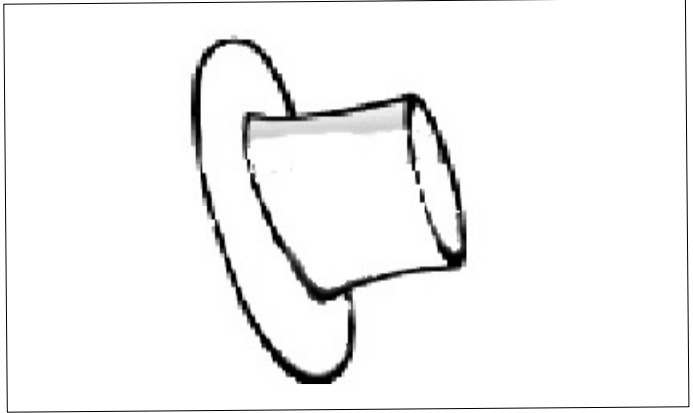
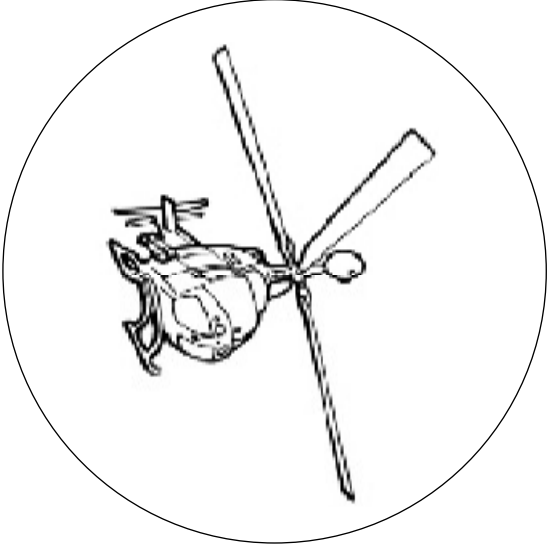

My Letter

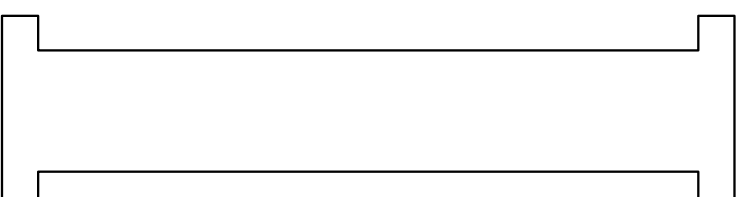

Book

Name

I i

is for

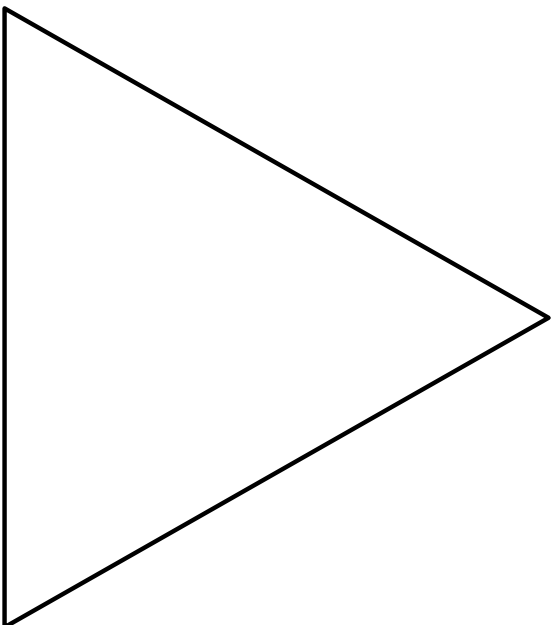

inch

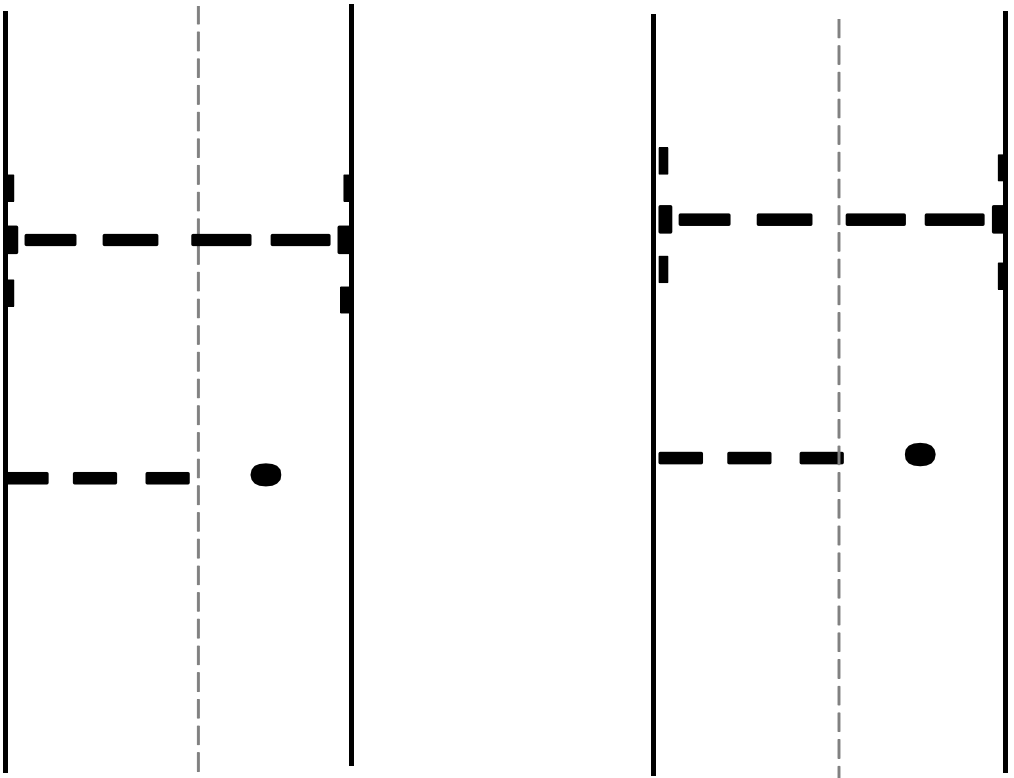

I i

is for

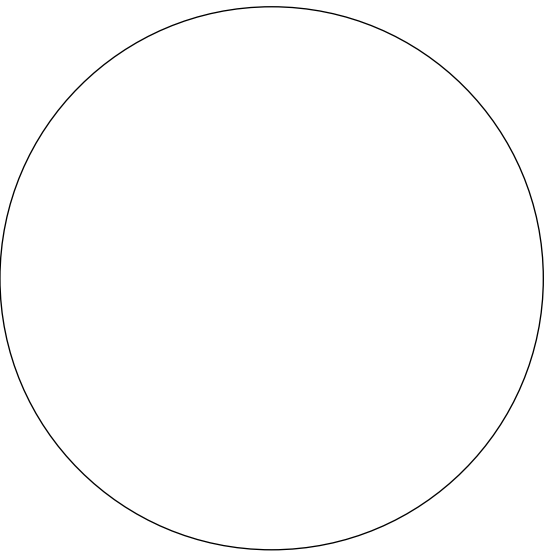

iguana

I i

is for

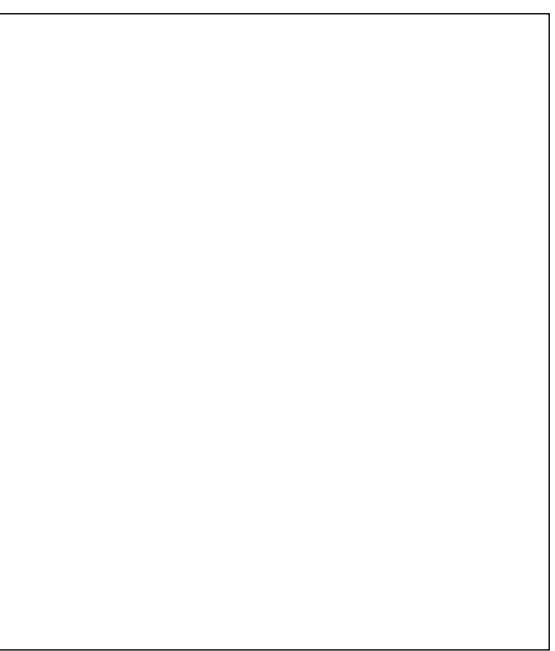

igloo

Ii

is for

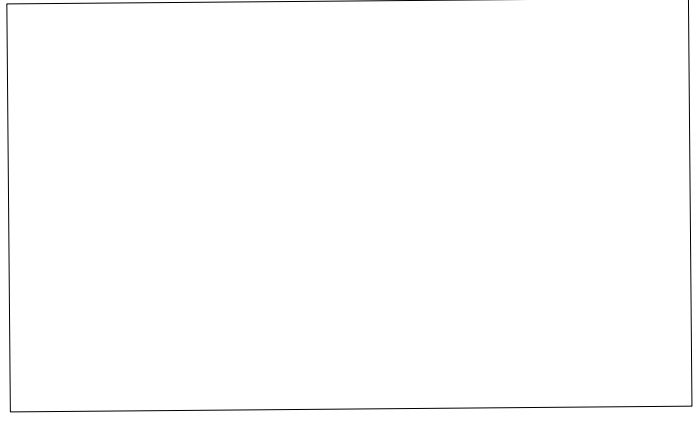

Indian

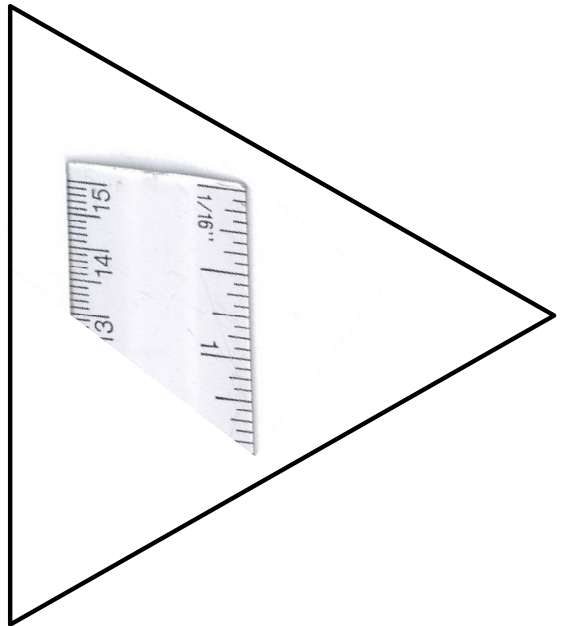
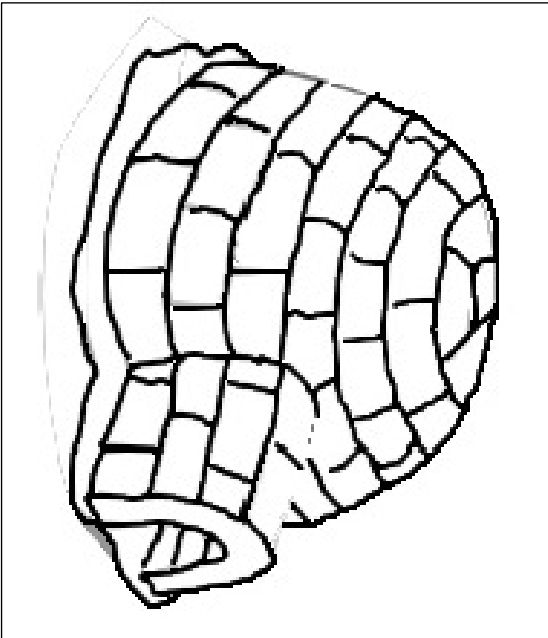
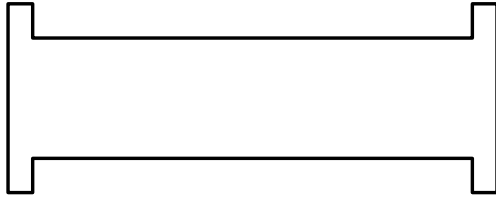
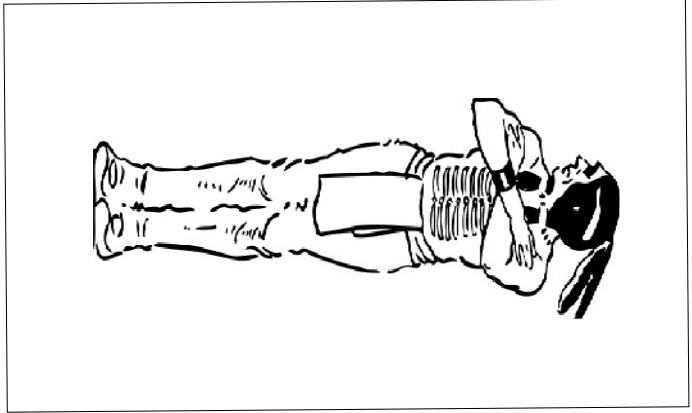

My Letter

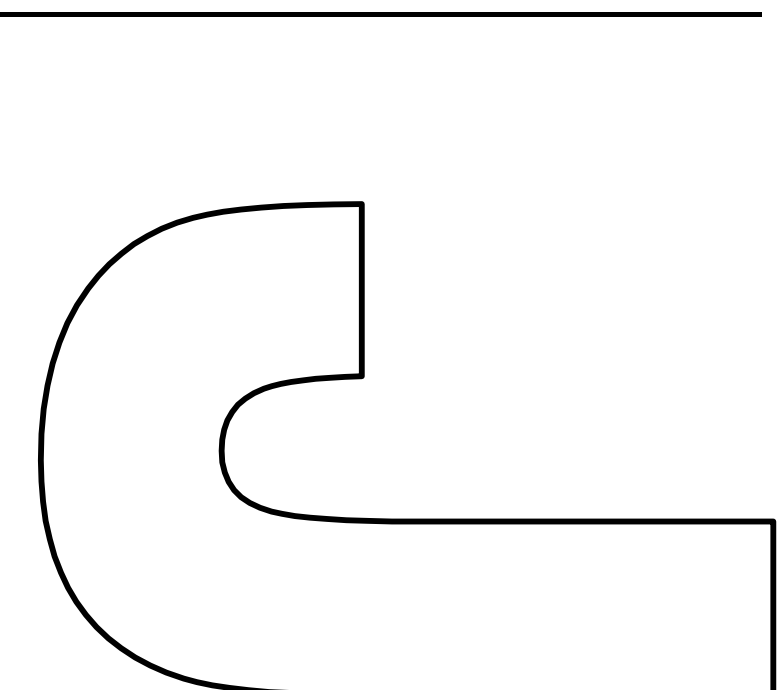

Book

Name

J j

is for

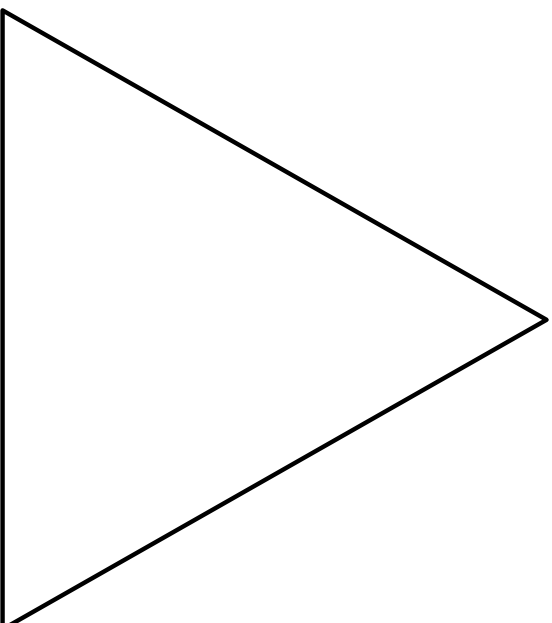

jar

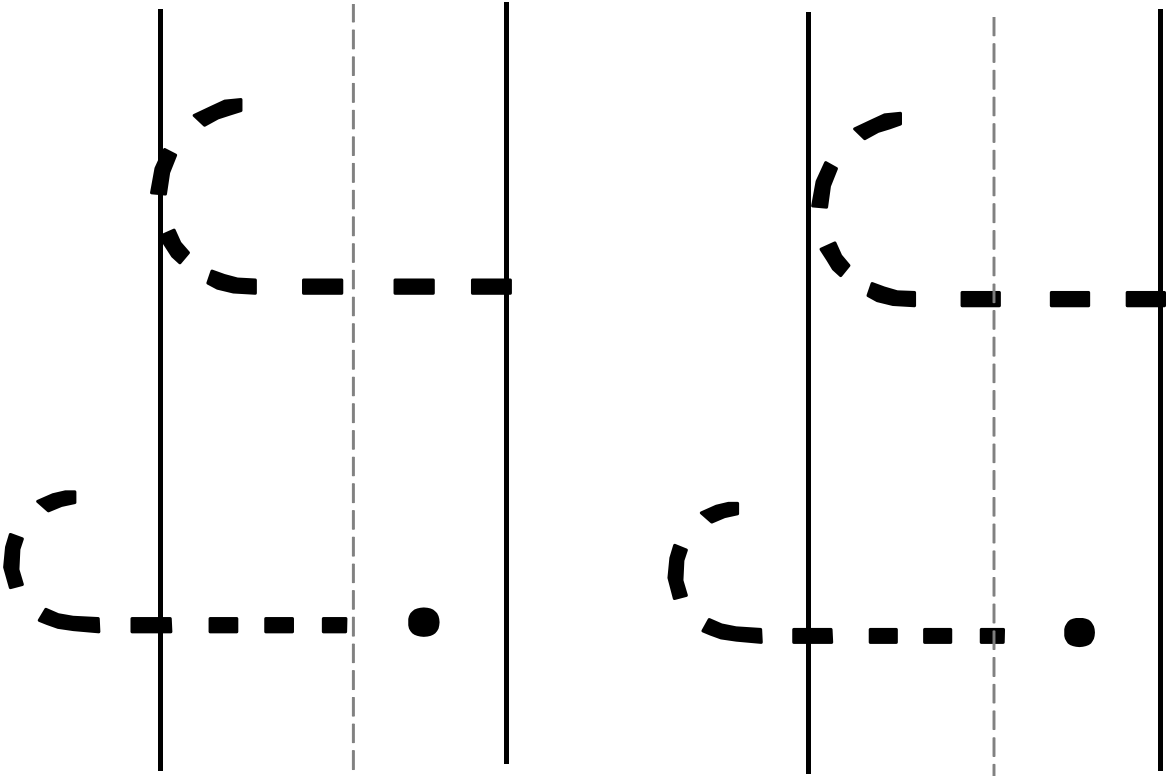

J j

is for

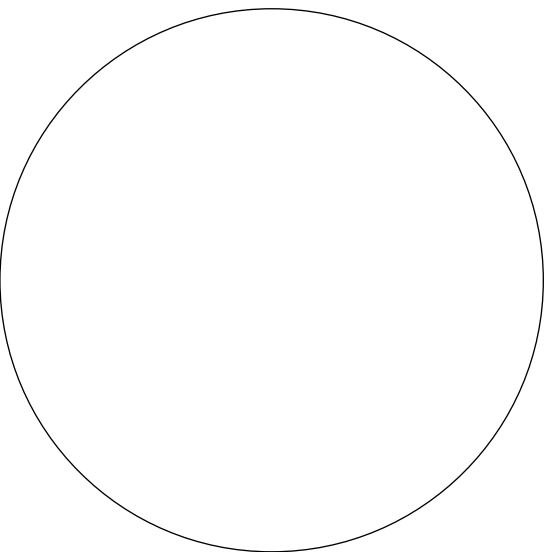

jack-o-lantern

J j

is for

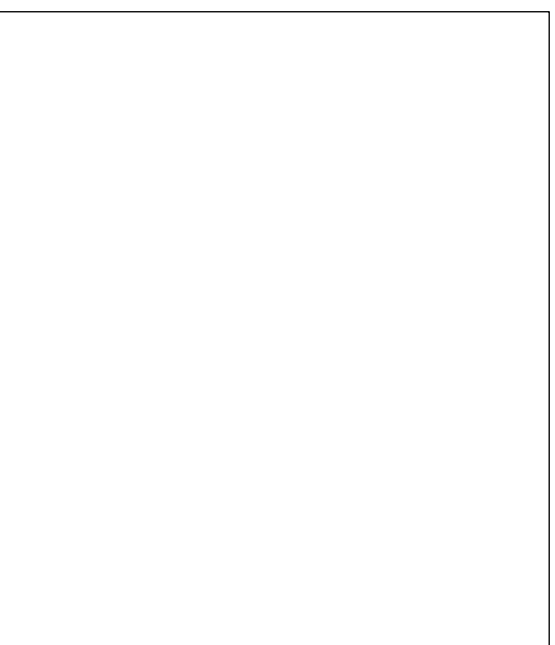

jeep

Jj

is for

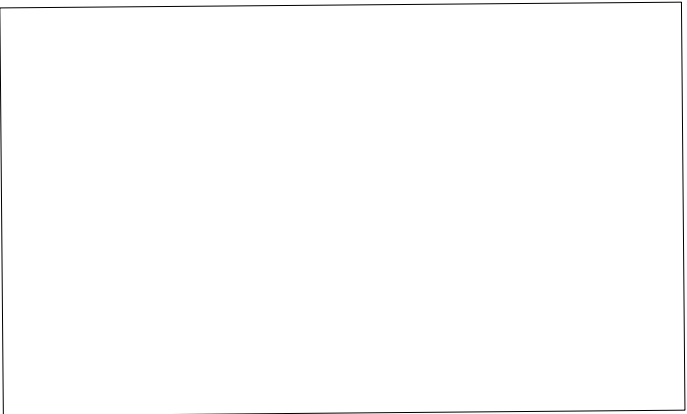

jump

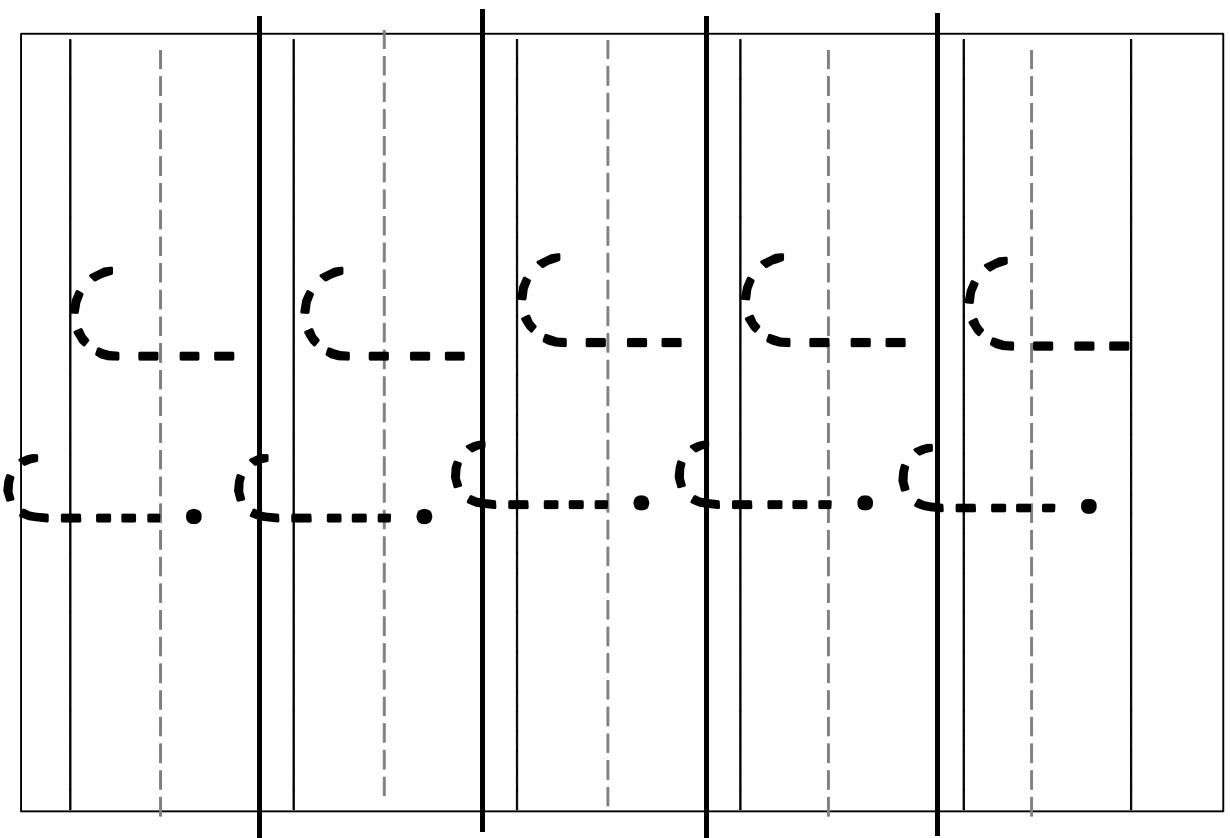

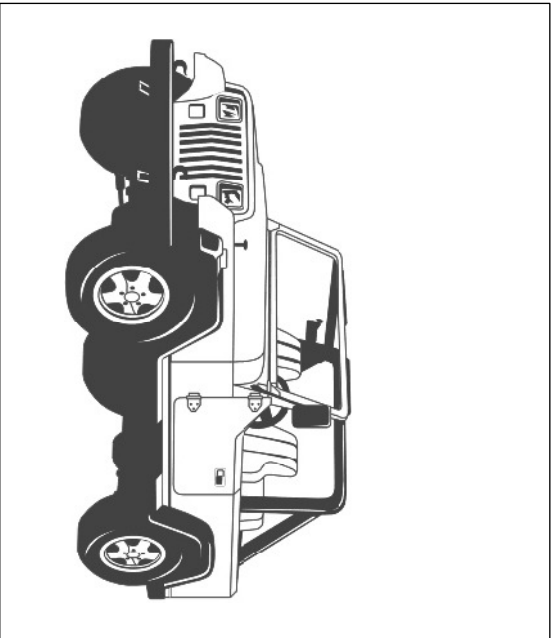
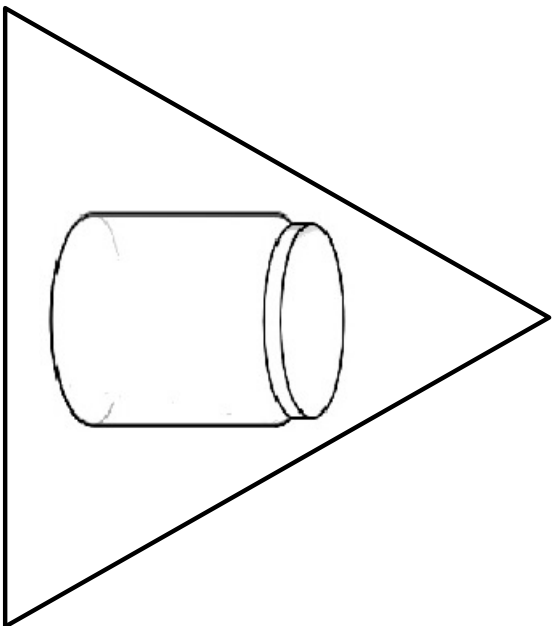
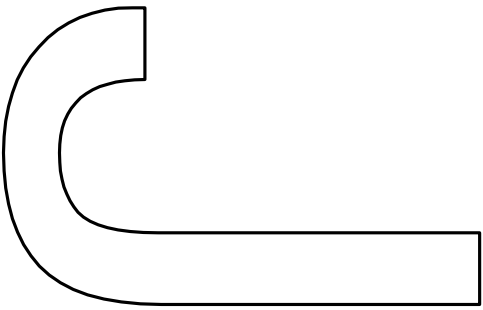
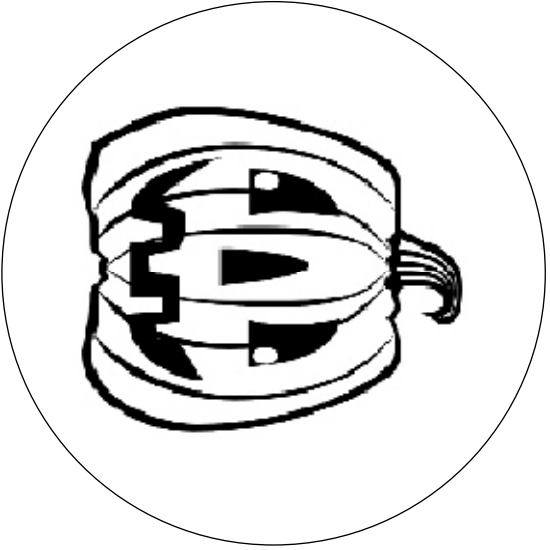
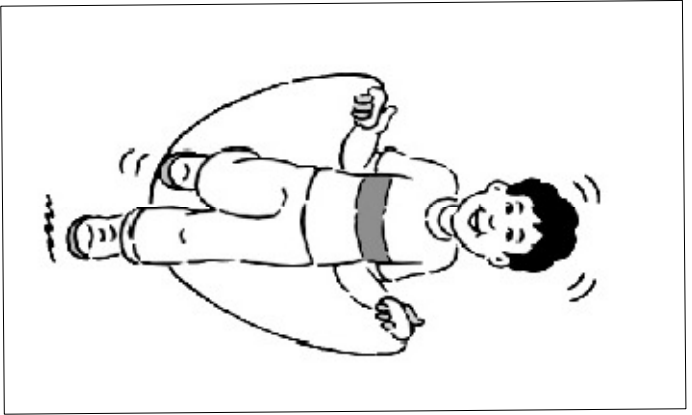

My Letter

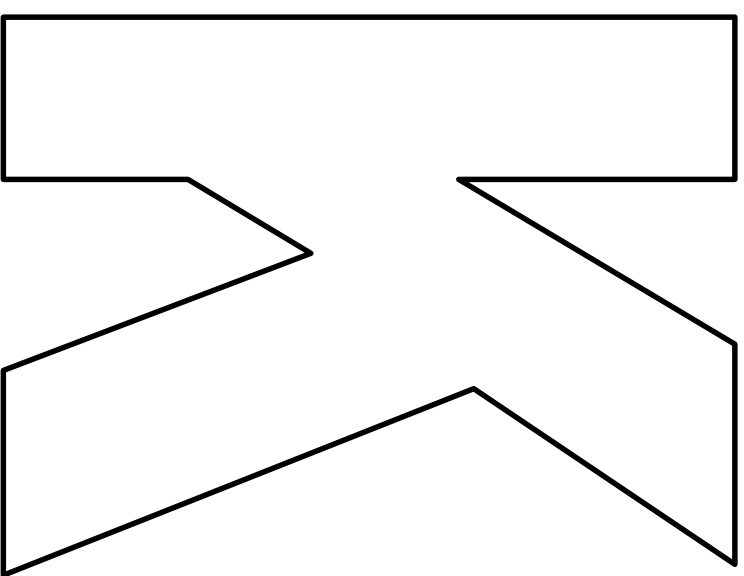

Book

Name

K k

is for

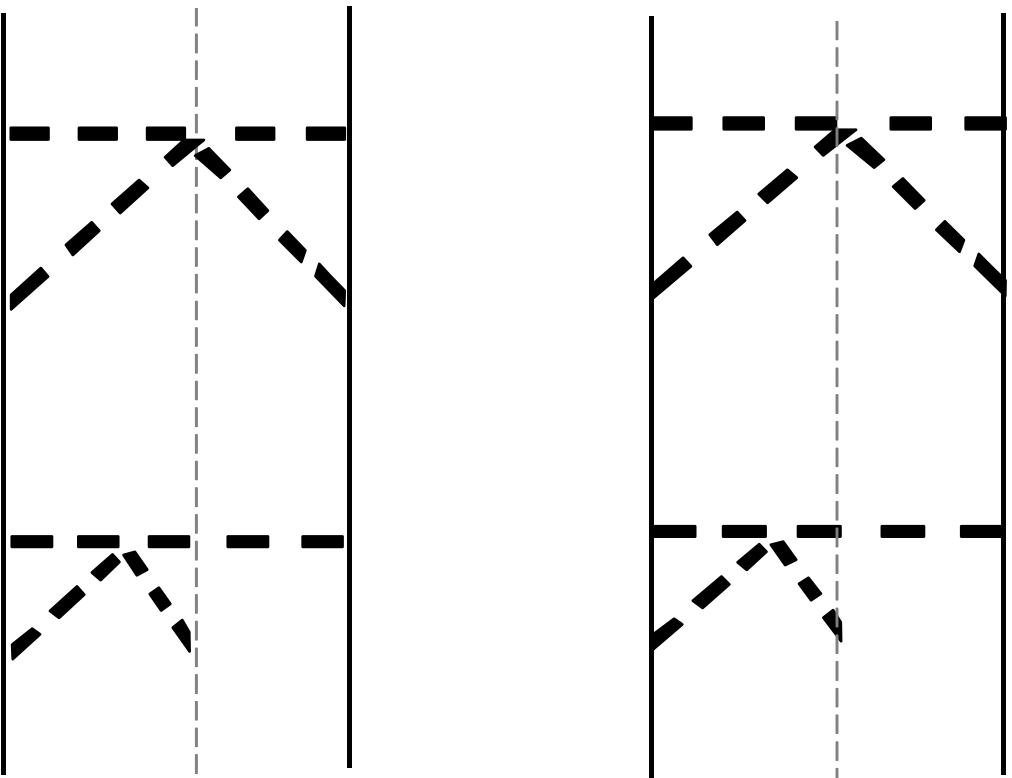
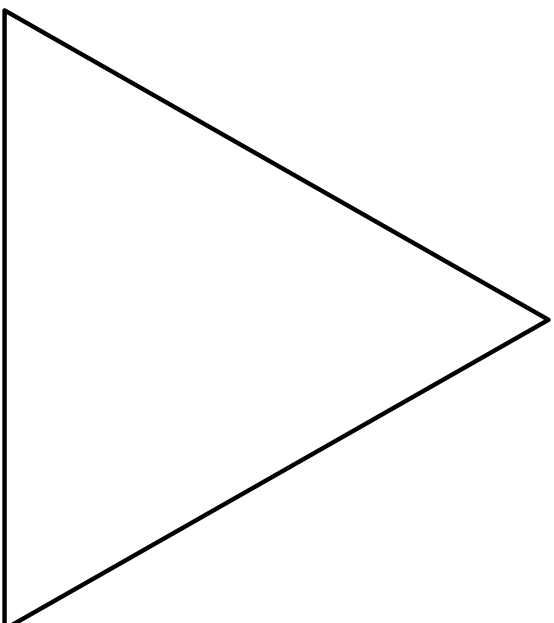

kettle

K k

is for

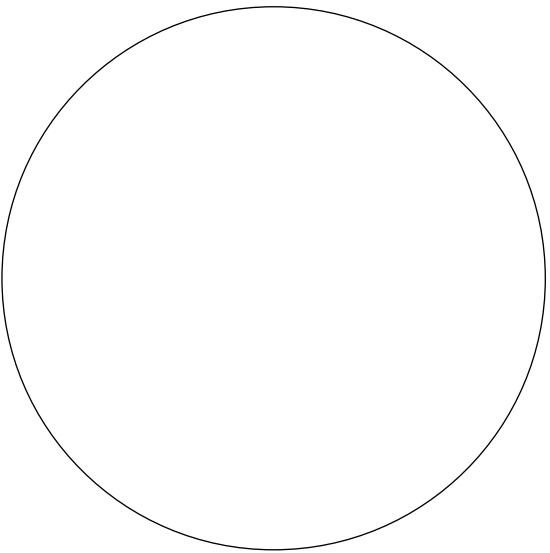

kangaroo

K k

is for

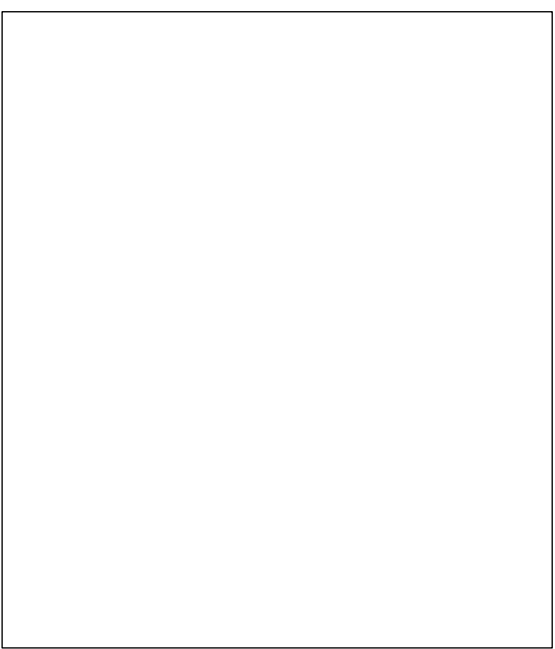

kitchen

K k

is for

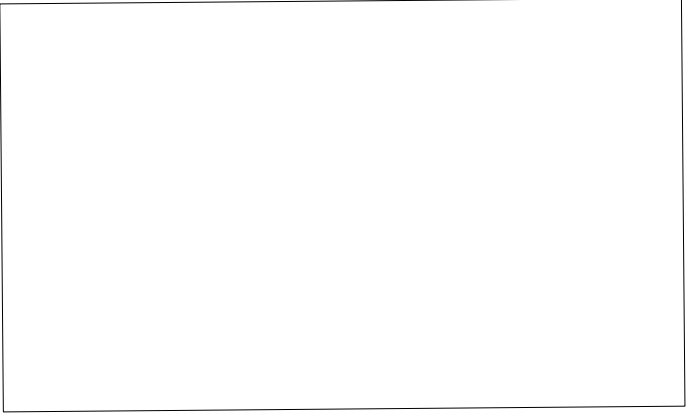

kite

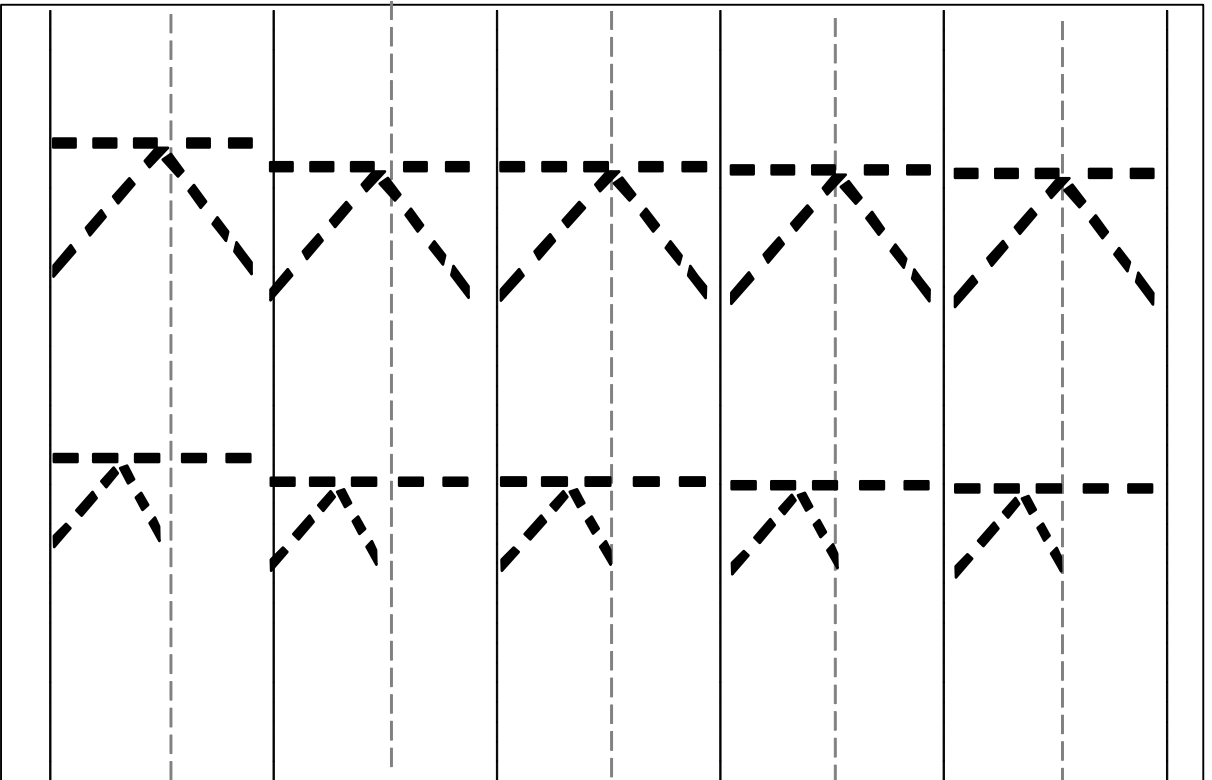

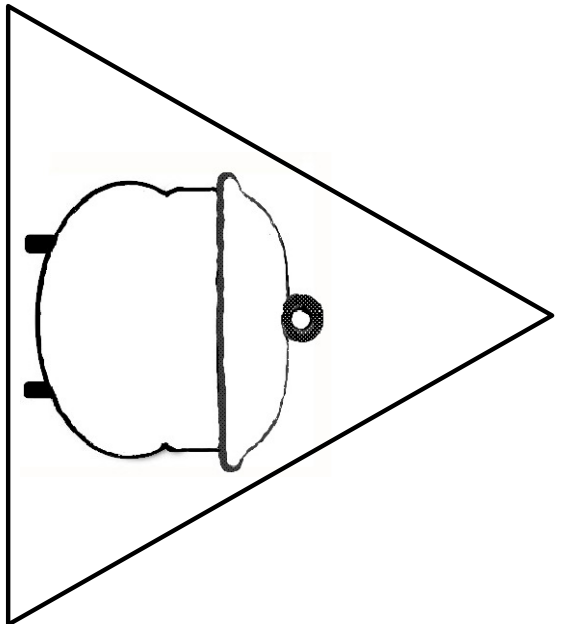
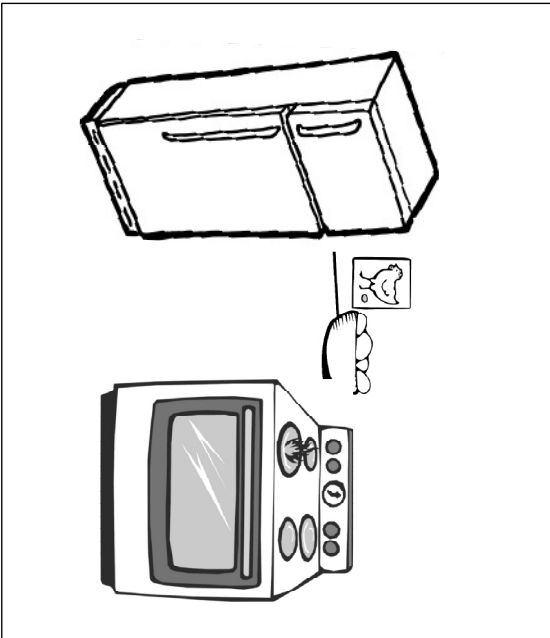
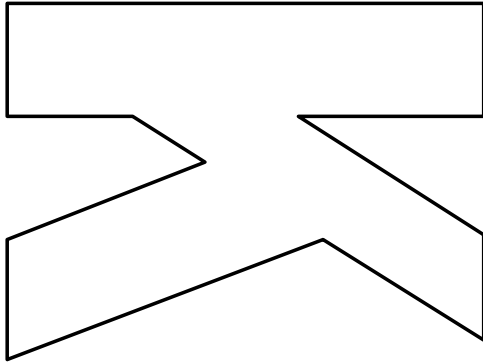
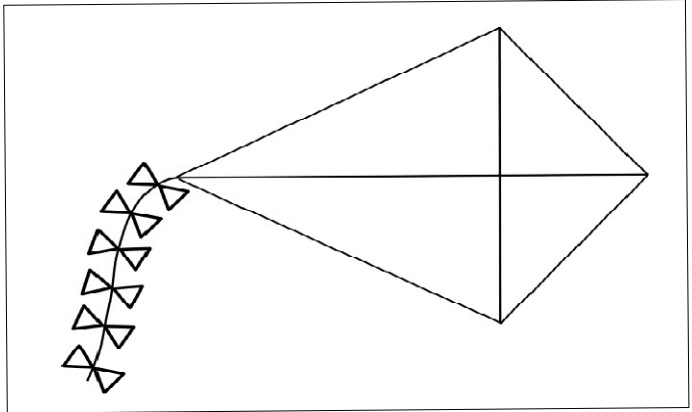

My Letter

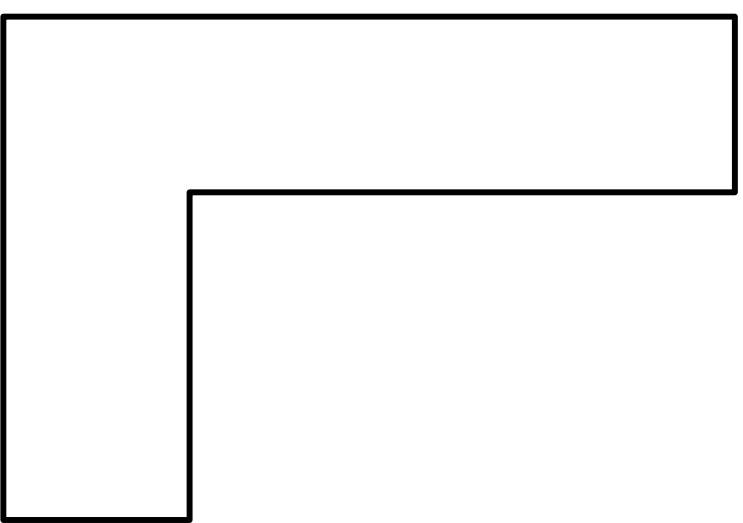

Book

Name

L |

is for

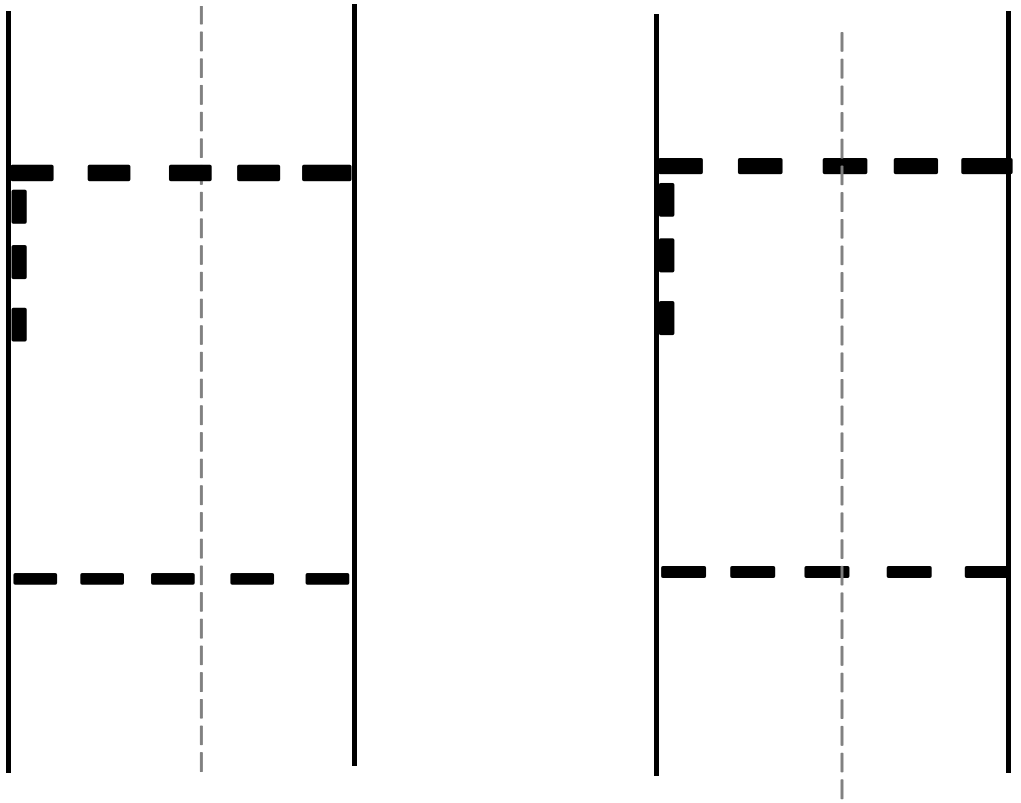
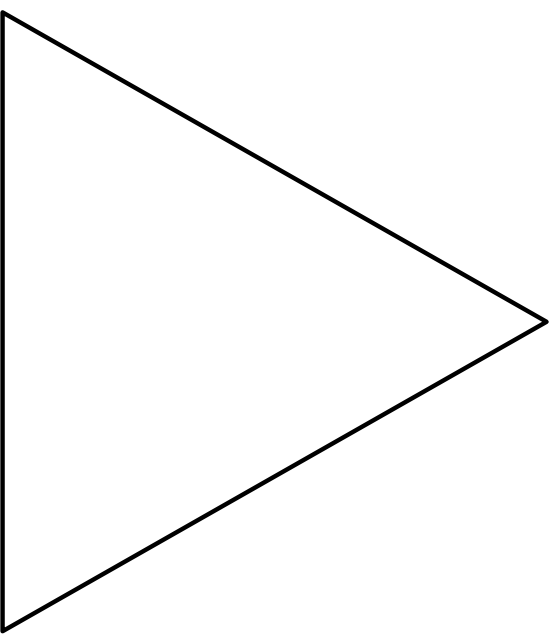

lemon

Ll

is for

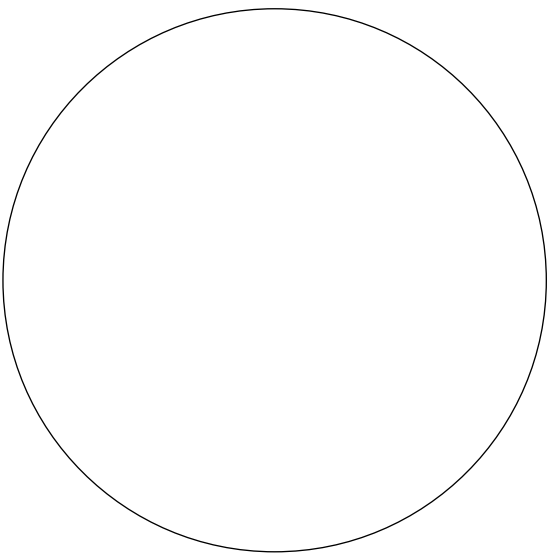

lips

Ll

is for

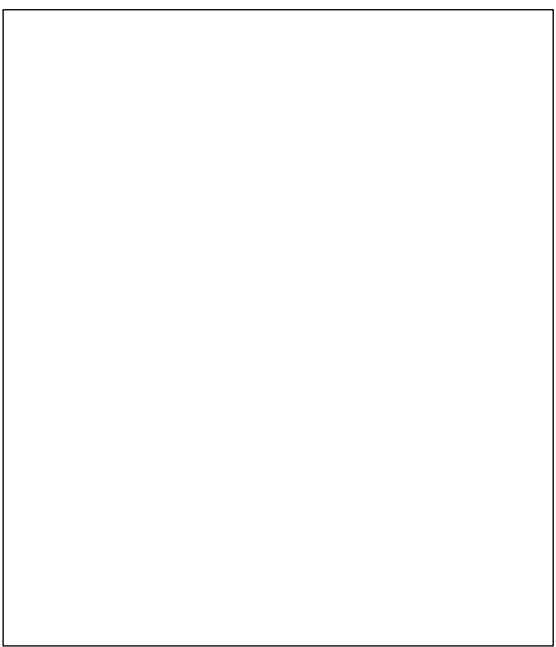

lion

lollypop

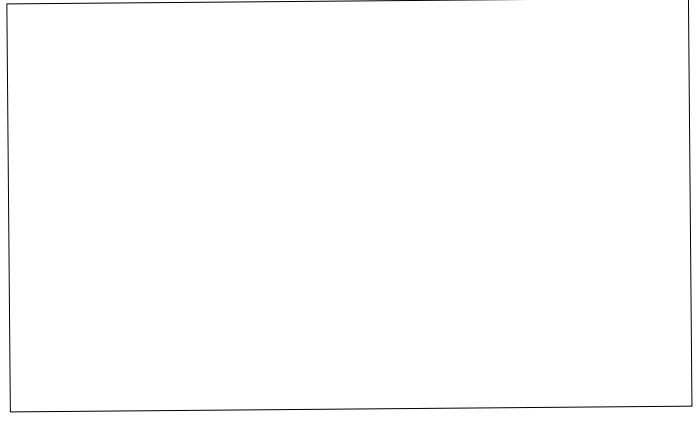

is for

L l

Handwriting practice section with five columns. Each column contains a dashed uppercase letter 'L' and a dashed lowercase letter 'l' for tracing. The letters are positioned between a solid top line and a solid bottom line, with a dashed midline. A solid horizontal line is located above the first column.

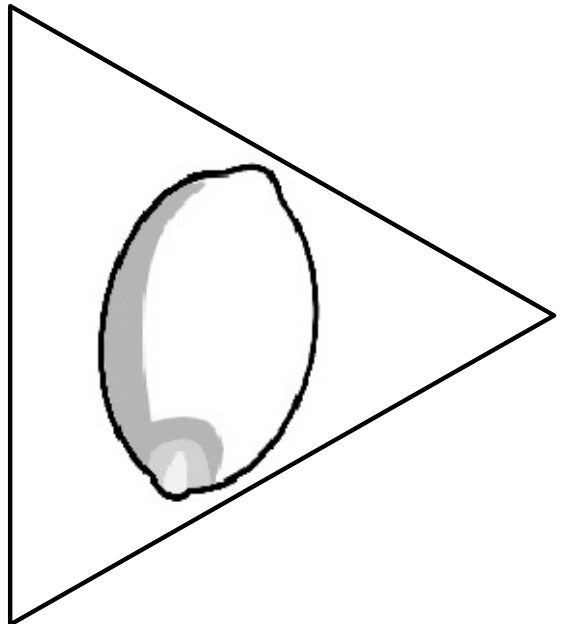
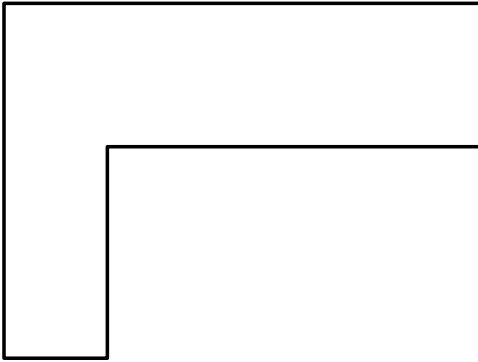
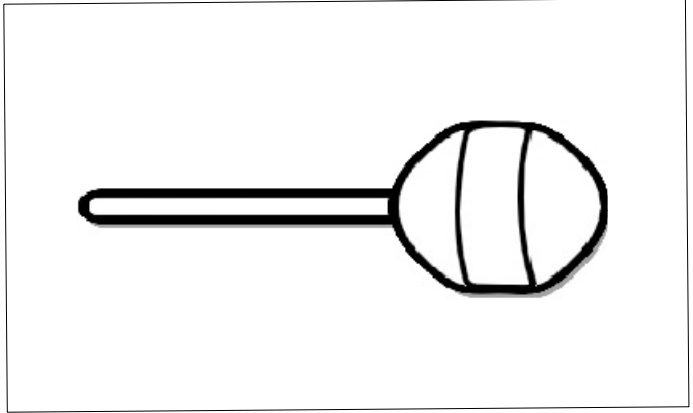
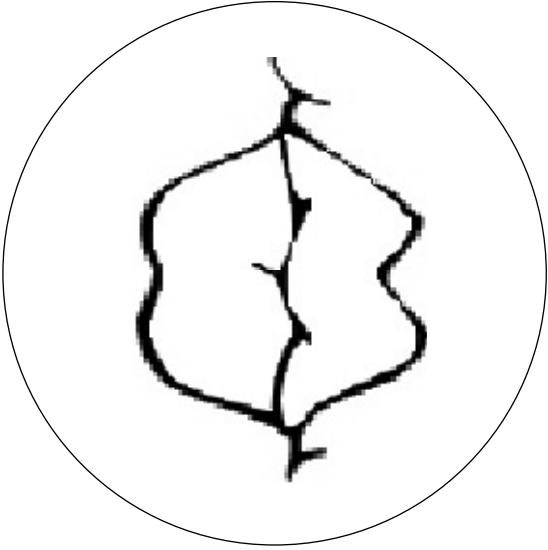

My Letter

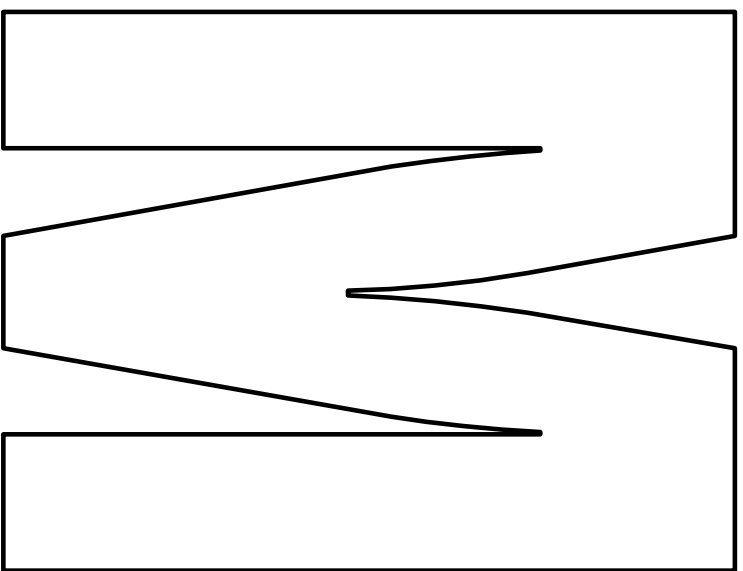

Book

Name

M m

is for

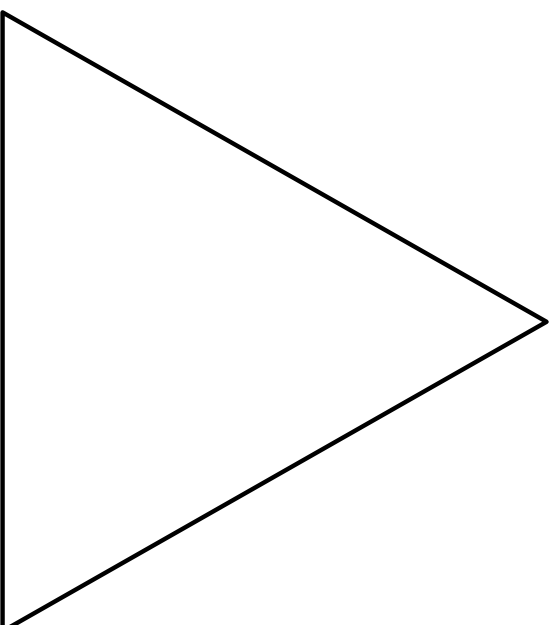

moon

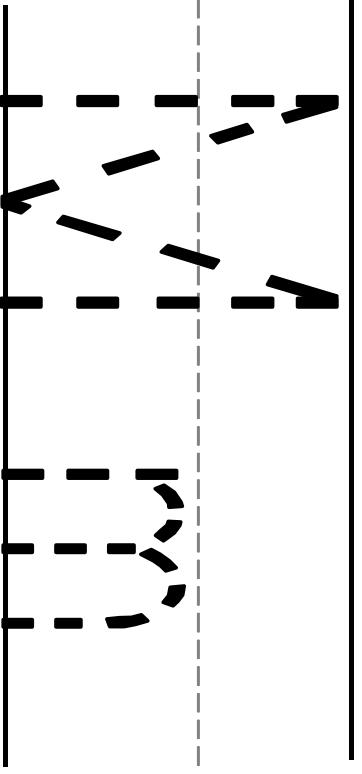
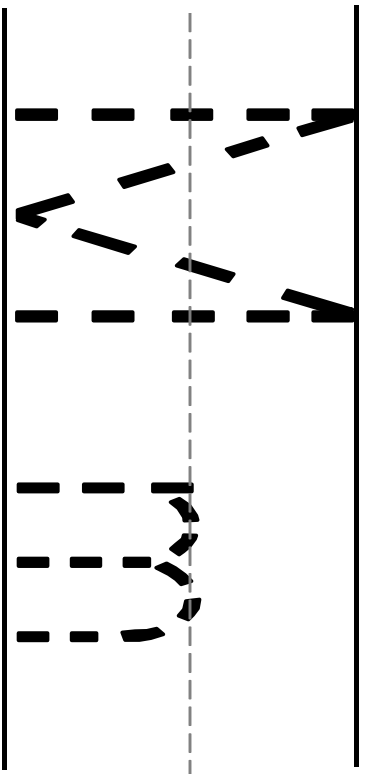

M m

is for

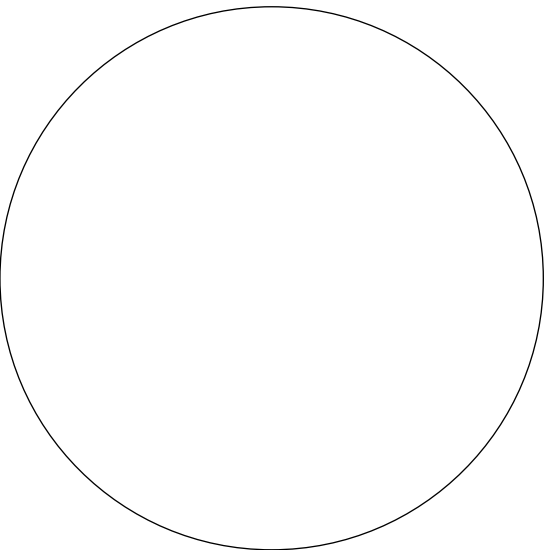

mouse

M m

is for

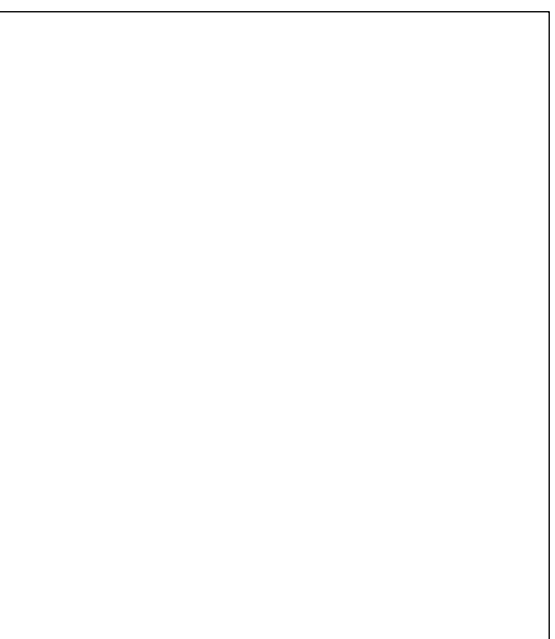

monkey

M m

is for

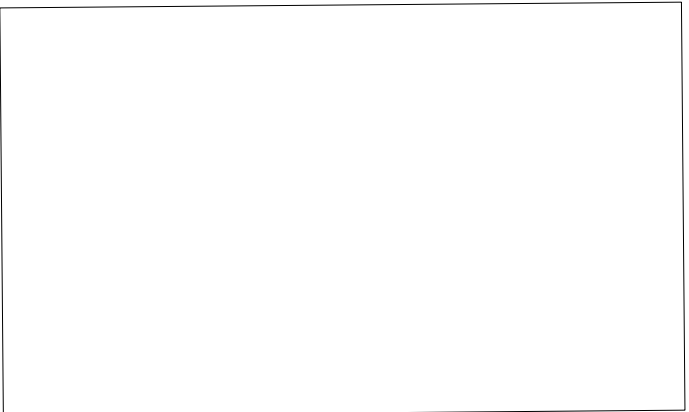

money

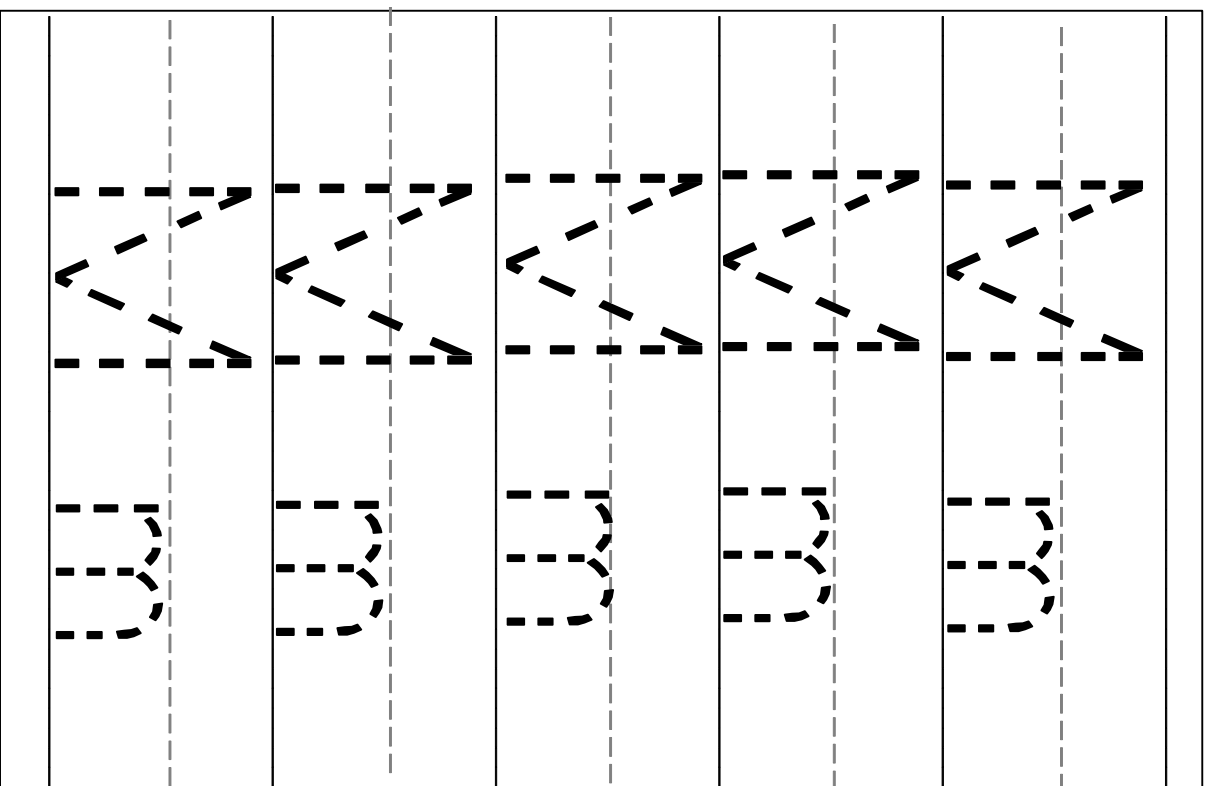

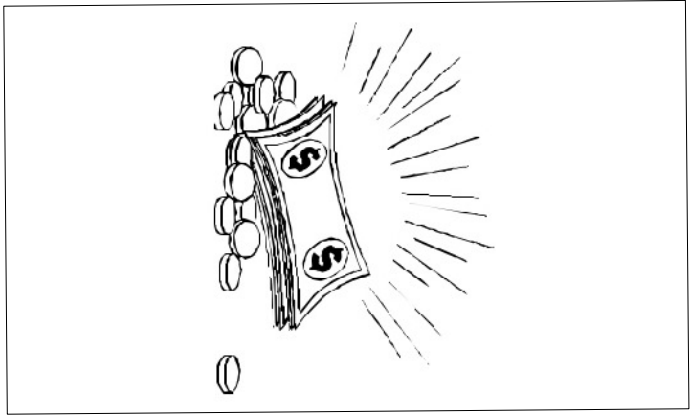
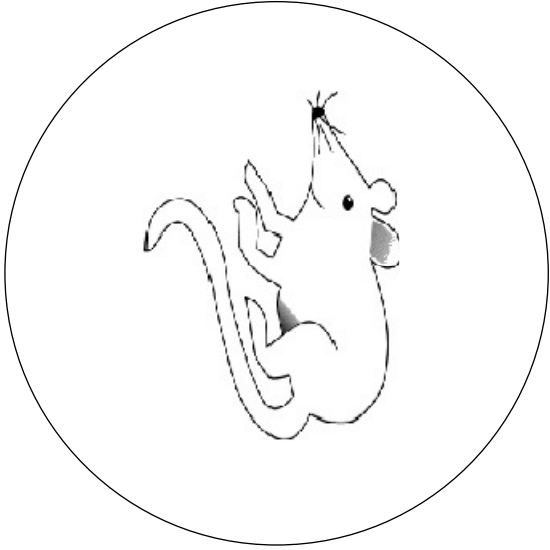

W

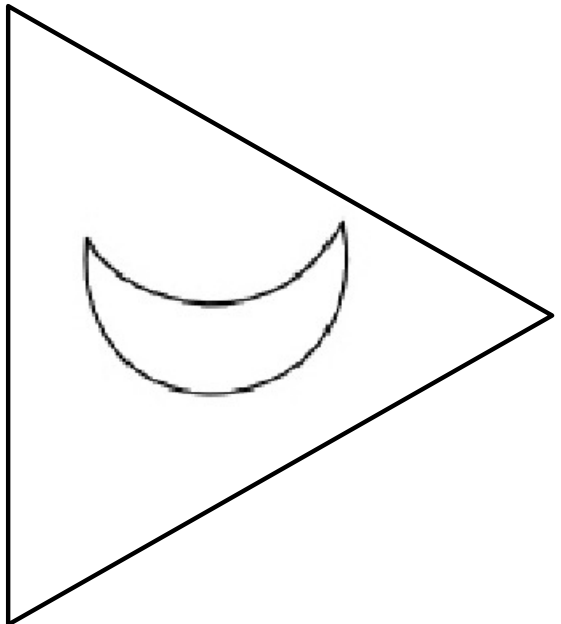
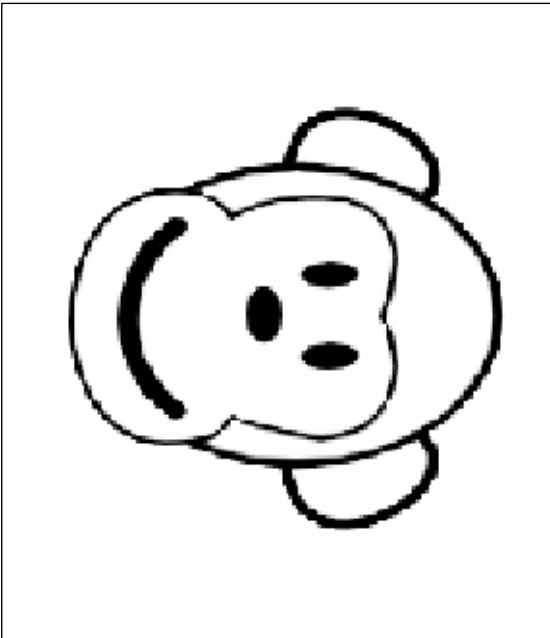

My Letter

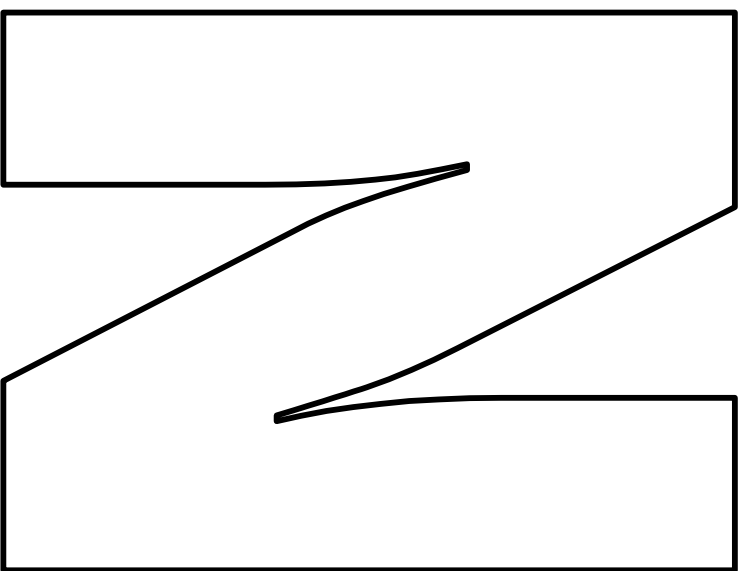

Book

Name

nails

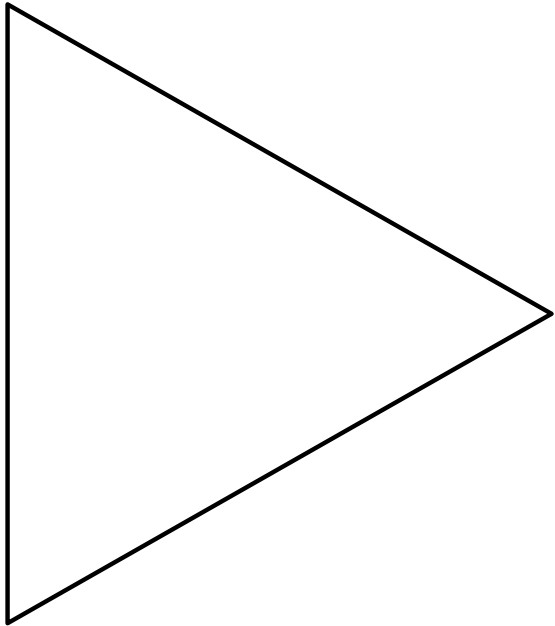

is for

N n

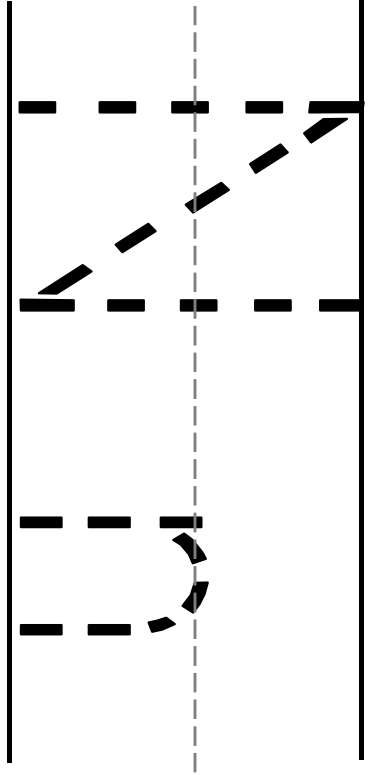
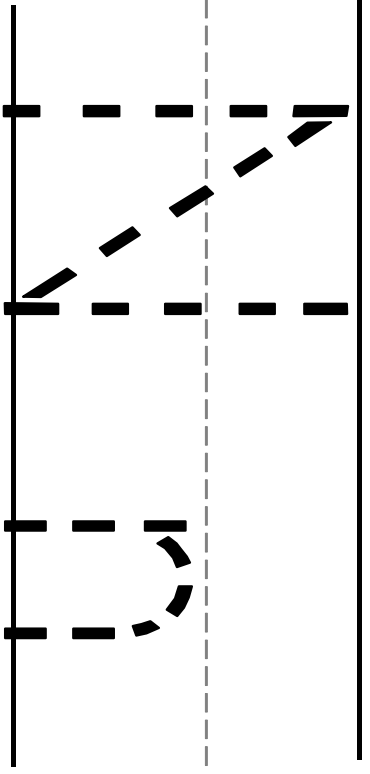

N n

is for

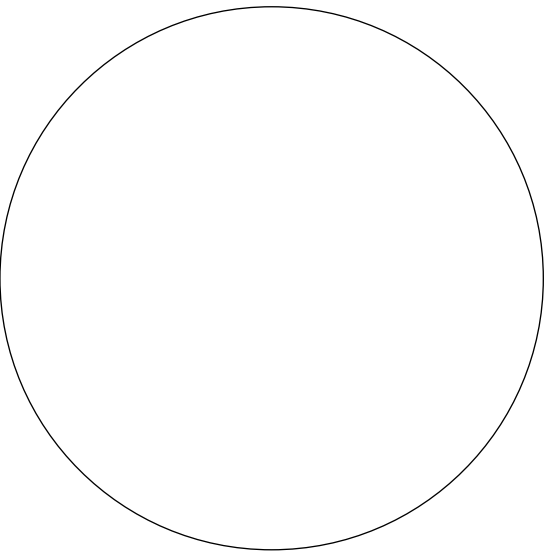

nuts

N n

is for

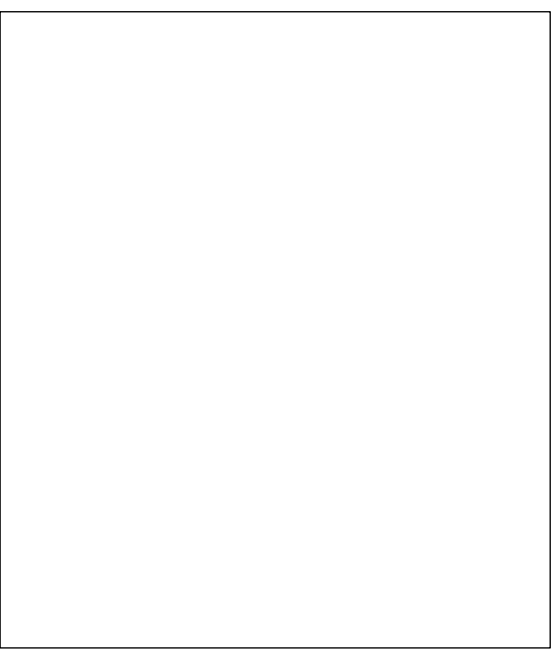

newspaper

N n

is for

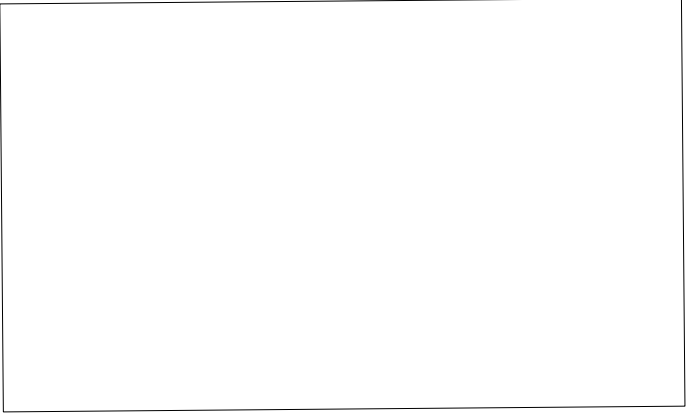

notebook

A dashed uppercase letter 'N' is positioned on a set of three horizontal handwriting lines (top, middle, and bottom). The letter starts at the top line, goes down to the middle line, then diagonally up to the top line, and finally down to the bottom line.	A dashed lowercase letter 'n' is positioned on a set of three horizontal handwriting lines. The letter starts at the middle line, goes down to the bottom line, then diagonally up to the top line, and finally down to the bottom line.	A dashed uppercase letter 'N' is positioned on a set of three horizontal handwriting lines.	A dashed lowercase letter 'n' is positioned on a set of three horizontal handwriting lines.	A dashed uppercase letter 'N' is positioned on a set of three horizontal handwriting lines.	A dashed lowercase letter 'n' is positioned on a set of three horizontal handwriting lines.	A dashed uppercase letter 'N' is positioned on a set of three horizontal handwriting lines.	A dashed lowercase letter 'n' is positioned on a set of three horizontal handwriting lines.
---	--	---	---	---	---	---	---

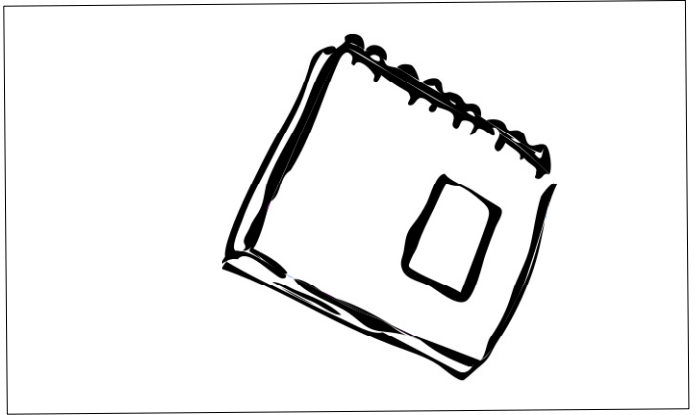
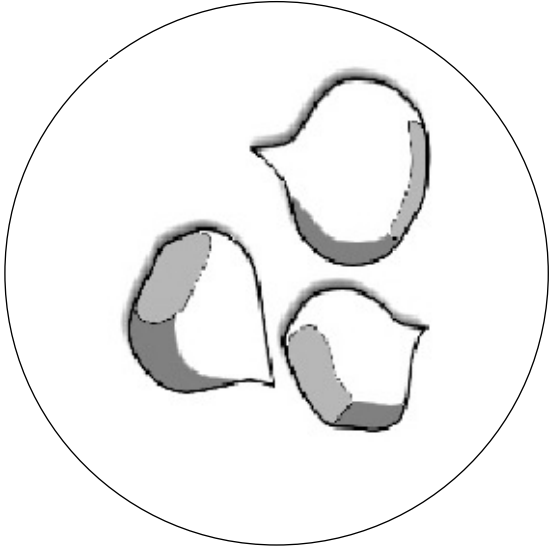

Z

